

## ASPECTS OF CYCLIC AND ACYCLIC PHOSPHORUS-NITROGEN COMPOUNDS

Robert A. Shaw

Department of Chemistry, Birkbeck College (University of London), Malet Street, London WC1E 7HX, U.K.

**Abstract** - The reactions of cyclic, e.g.,  $N_3P_3Cl_6$ ,  $N_4P_4Cl_8$ , and acyclic, e.g.,  $Cl_2P(O)N=PCl_2$ ,  $Cl_2PNMeP(O)Cl_2$  phosphorus-nitrogen compounds are compared. The reactions discussed include aminolysis, alcoholysis, hydrolysis, thioalcoholysis. Aminolysis products include spirocyclic and bicyclic structures. Molecular rearrangements involving migrations of alkyl groups from oxygen to nitrogen are reviewed and, more briefly, the movements of silyl groups amongst oxygen and nitrogen atoms. Tautomerism is discussed; attempts are made to relate it to basicity and hence to make predictions which of the alternative tautomeric forms are preferred. Selected physico-chemical properties are compared. Structure and reactivity are discussed.

### INTRODUCTION

The field of phosphorus-nitrogen chemistry has grown, and is continuing to grow, explosively. Whilst in earlier years most of the work was devoted to cyclophosphazenes, more recently cyclophosphazanes and acyclic phosphorus-nitrogen compounds have attracted increasing attention. Whilst a plenary lecturer has more time at his disposal than those presenting contributed papers, even he must be selective. This I have been. The choice is inevitably a personal one. I hope however that the subjects I have chosen to review will be of interest to most of you.

### AMINOLYSIS

A great deal of work has been done in the field of aminolysis, and I surveyed this in some detail in Besançon (1). Hence I will confine myself now to recent developments in cyclic and acyclic phosphorus-nitrogen compounds and will also attempt some generalisations.

#### Primary amines

##### (a) Hexachlorocyclotriphosphazatriene, $N_3P_3Cl_6$ (1)

When the affinity between the phosphorus substrate and the amine is high, nongeminal structures are found; when the affinity is low, geminal derivatives result (2). This can be summarised for the three primary amines,  $NH_2Et$ ,  $NH_2Pr^i$  and  $NH_2Bu^t$ .

| $NH_2R$  | $N_3P_3Cl_6$ |                  |                |
|--|--------------|------------------|----------------|
|  | $NH_2Et$ (2) | $NH_2Pr^i$ (3,4) | $NH_2Bu^t$ (5) |
| $N_3P_3Cl_5(NHR)$  | +            | +                | +              |
| $N_3P_3Cl_4(NHR)$ $\left\{ \begin{array}{l} \text{cis} \\ \text{trans} \\ \text{gem.} \end{array} \right.$ | +            | +                |                |
|  |              | +                | +              |
| $N_3P_3Cl_2(NHR)_4$ gem.   | +            | +                | +              |

The dominant rôle of the attacking nucleophile as against that of the substituent already present is borne out by the structures and the mode of formation of the mixed derivatives,  $N_3P_3Cl_4(NH_2Et)(NHBu^t)$  (6).

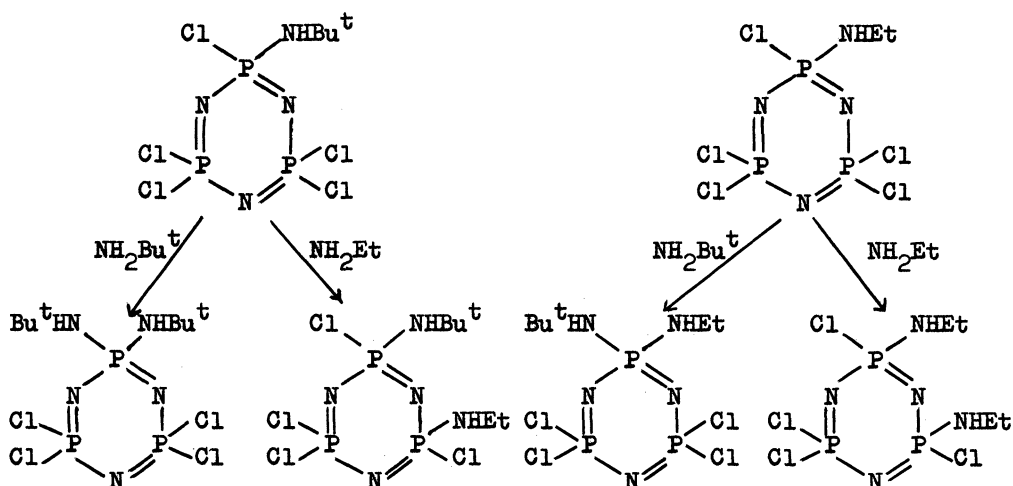

(b) Octachlorocyclophosphazene,  $N_4P_4Cl_8$  (2)

This phosphazene is considerably more reactive than its lower homologue,  $N_3P_3Cl_6$  (1) towards nucleophilic attack. The number of possible isomers is also considerably greater, and so is the difficulty in determining their structure, especially *cis-trans* relationships. After the tetra stage of substitution with primary amines [ $N_4P_4Cl_4(NHR)_4$ ] only the octa-derivatives,  $N_4P_4(NHR)_8$ , have been isolated. Side-reactions (see below) are the cause of this.

The more reactive amines give 2,6-disubstituted products (7), the less reactive 2,4- as well as 2,6-derivatives (8). In contrast to the trimer system, in the tetramer system no geminal isomers have to date been observed with primary amines.

As for the trimer, the nature of the nucleophile also determines the structure of the products in the tetramer system. This is summarised for the nucleophiles,  $NH_2Et$  and  $NH_2Bu^t$  (7,8).

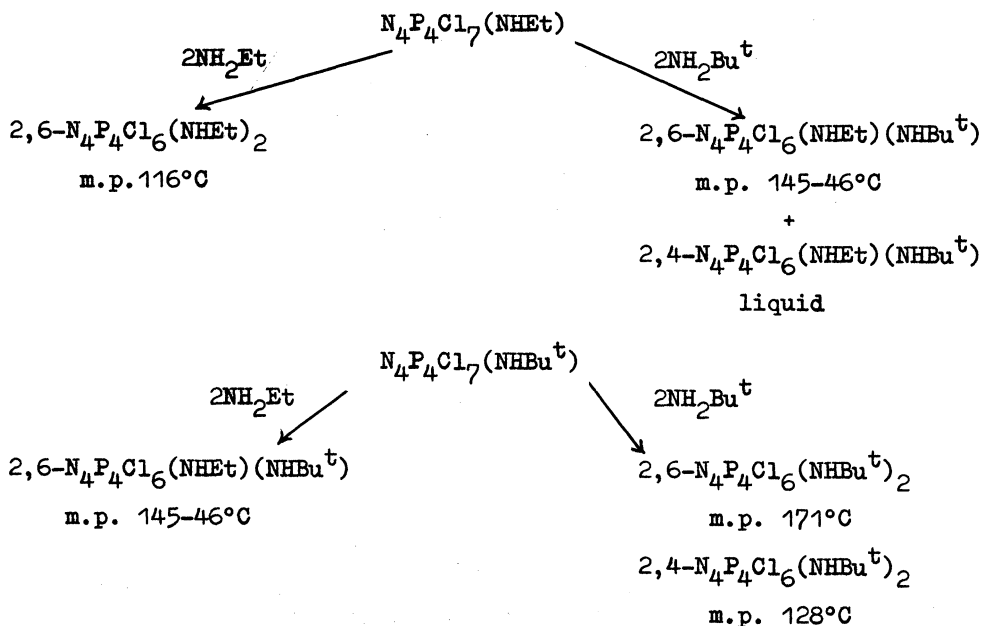

(c) Dichlorophosphinyltrichlorophosphazene,  $\text{Cl}_2\text{P}(\text{O})\text{N}=\text{PCl}_3$  (3)  
 Bulloch and Keat (9) have investigated the reactions of the above compound with two primary amines,  $\text{NH}_2\text{Me}$  and  $\text{NH}_2\text{Bu}^t$ . Their conclusions can be summarised as follows:

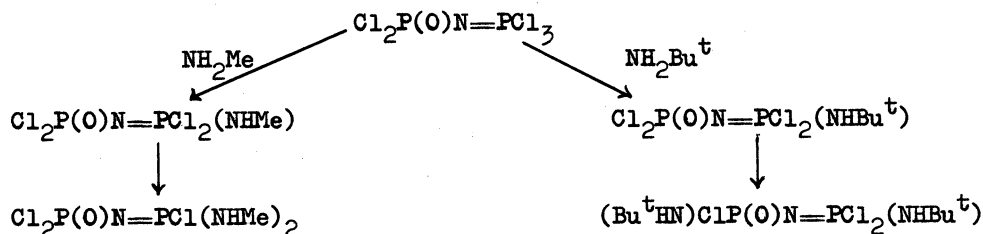

Initial aminolysis with both amines takes place at the phosphazanyl centre; further reaction with methylamine gives a geminal compound, but with t-butylamine, a nongeminal compound is obtained.  $^{31}\text{P}$  n.m.r. spectroscopy shows that both phosphorus nuclei in  $\text{Cl}_2\text{P}(\text{O})\text{N}=\text{PCl}_2(\text{NHBu}^t)$  are coupled to an NH proton [ $\underline{J}(\underline{\text{P}}-\underline{\text{H}}) = 14.5$  and  $4.9$  Hz.]; the authors speculate about a tautomeric shift

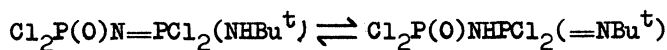

$^{31}\text{P}$  n.m.r. chemical shifts (relative to 85%  $\text{H}_3\text{PO}_4$ ) and in brackets  $^2\text{J}(\text{P}-\text{P})$  coupling constants in Hz.

|   |       |        |  |      |        |
|---|-------|--------|--|------|--------|
| $\text{Cl}_2\text{P}(\text{O})\text{N}=\text{PCl}_3$              |       |        |  |      |        |
| -13.9   | -0.4  | (17.0) |  |      |        |
| $\text{Cl}_2\text{P}(\text{O})\text{N}=\text{PCl}_2(\text{NHMe})$ |       |        | $\text{Cl}_2\text{P}(\text{O})\text{N}=\text{PCl}_2(\text{NHBu}^t)$              |      |        |
| -9.0  | +7.0  | (29.9) | -10.8  | -1.8 | (25.4) |
| $\text{Cl}_2\text{P}(\text{O})\text{N}=\text{PCl}(\text{NHMe})_2$ |       |        | $(\text{Bu}^t\text{HN})\text{ClP}(\text{O})\text{N}=\text{PCl}_2(\text{NHBu}^t)$ |      |        |
| -9.8  | +16.9 | (35.6) | -6.4   | -3.9 | (33.2) |

As the phosphinyl phosphorus shows a significant, and approximately constant, chemical shift in all aminolysis products containing the  $\text{P}(\text{O})\text{Cl}_2$  group, I prefer an explanation different from the tautomer postulated, namely, one based on an intramolecular hydrogen-bond, e.g.,

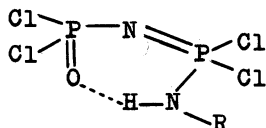

or alternatively on an intermolecularly hydrogen-bonded dimer. This explanation seems to me to be more in keeping with the chemical shifts and with the  $^2\text{J}(\underline{\text{P}}-\underline{\text{P}})$  coupling constants, the latter, I consider being too high for a phosphazane structure and more in keeping with coupling across a phosphazene moiety.

This hydrogen-bonded structure could also possibly explain the divergence of reaction sites on disubstitution. In  $\text{N}_3\text{P}_3\text{Cl}_6$  (1) the predominant mode of substitution by  $\text{NH}_2\text{Bu}^t$ , is geminal, by  $\text{NH}_2\text{Me}$  and  $\text{NH}_2\text{Et}$  nongeminal. For the former a proton abstraction mechanism is postulated (5), for the latter direct nucleophilic attack by the reagent on phosphorus (2). It is conceivable that the more reactive smaller amine,  $\text{NH}_2\text{Me}$ , reacts with  $\text{Cl}_2\text{P}(\text{O})\text{N}=\text{PCl}_2(\text{NHMe})$  by the latter mechanism, whilst the bulkier amine,  $\text{NH}_2\text{Bu}^t$ , would have preferred a proton abstraction route. It is probably prevented from doing this by strong hydrogen-bonding and hence it attacks the other, less hindered, phosphorus centre, the phosphinyl group. The structure of 'mixed' derivatives containing one  $\text{NHMe}$  and one  $\text{NHBu}^t$

substituent introduced in different sequences would be as revealing, as they were for NHEt and NHBu<sup>t</sup> in the N<sub>3</sub>P<sub>3</sub>Cl<sub>6</sub> (1) and in the N<sub>4</sub>P<sub>4</sub>Cl<sub>8</sub> (2) systems.

(d) Phosphorus trichloride, PCl<sub>3</sub>

Steric effects are also noticeable in the reaction of phosphorus trichloride with primary amines, NH<sub>2</sub>R, (R = Me, Et, Pri, Bu<sup>t</sup>) (10). Two types of product were observed, bis(dichlorophosphino)amines, (Cl<sub>2</sub>P)<sub>2</sub>NR, and cyclophosph(III)-azanes (mainly dimers), (ClPNR)<sub>2</sub>.

| R               | (Cl <sub>2</sub> P) <sub>2</sub> NR | (ClPNR) <sub>2</sub> |
|-----------------|-------------------------------------|----------------------|
| Me              | +                                   |                      |
| Et              | +                                   | +                    |
| Pr <sup>i</sup> |                                     | +                    |
| Bu <sup>t</sup> |                                     | +                    |

It would be attractive to rationalise these results by postulating the same two mechanistic routes:

- (1) direct nucleophilic attack by the smaller, more reactive, amines on phosphorus to give the bis(dichlorophosphino)amines;
- (2) proton abstraction by the bulkier amines to give the cyclodiphosph(III)azanes, probably by a dimerisation reaction.

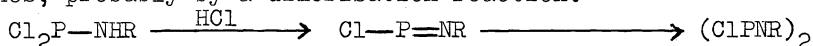

However the isolation of intermediates, e.g., Cl<sub>2</sub>PNRClNHR, mitigates against, although does not disprove, the second postulate.

(e) Bis(dichlorophosphino)-, (Cl<sub>2</sub>P)<sub>2</sub>NR, bis(dichlorophosphinyl)-, [Cl<sub>2</sub>P(O)]<sub>2</sub>NR and bis(dichlorophosphinothiyl)-amines, [Cl<sub>2</sub>P(S)]<sub>2</sub>NR

All the above phosphorus compounds (R = alkyl) react with 3 mol equivalents of t-butylamine to give the corresponding cyclodiphosph[(III) or (V)]azanes, [ClP(X)NR]<sub>2</sub> (X = lone pair, O or S) (11). Here we have another example of a primary amine acting as a 'bifunctional' reagent, both in the synthesis of the acyclic precursors, as well as in that of the cyclic products.

Secondary amines

(a) Hexachlorocyclotriphosphazatriene, N<sub>3</sub>P<sub>3</sub>Cl<sub>6</sub> (1)

With the exception of aziridine, the reactions of secondary amines with N<sub>3</sub>P<sub>3</sub>Cl<sub>6</sub> (1) follow predominantly a nongeminal path (1). Only at the tris-amino stage, N<sub>3</sub>P<sub>3</sub>Cl<sub>3</sub>(NR<sub>2</sub>)<sub>3</sub>, can major amounts of a geminal isomer be obtained. This reaction is strongly solvent dependent, e.g., with NHEt<sub>2</sub> in acetonitrile only nongeminal *cis*- and *trans*-derivatives, N<sub>3</sub>P<sub>3</sub>Cl<sub>3</sub>(NEt<sub>2</sub>)<sub>3</sub> are observed, whilst in aromatic solvents, it is mainly the geminal tris-isomer which is obtained (1).

(b) Octachlorocyclo-tetraphosphazetetraene, N<sub>4</sub>P<sub>4</sub>Cl<sub>8</sub> (2)

This has been less well investigated than the trimer system (1). Two general observations can be made, albeit, on somewhat limited data. Geminal isomers, N<sub>4</sub>P<sub>4</sub>Cl<sub>5</sub>(NRR')<sub>3</sub> (R = R' = Me) (12) and, in particular, 2,2,6,6-N<sub>4</sub>P<sub>4</sub>Cl<sub>4</sub>(NRR')<sub>4</sub> (R = R' = Me (12); R = Me, R' = Ph (13)), have been isolated. No such geminal isomers have been observed with primary amines (contrast the N<sub>3</sub>P<sub>3</sub> system).

The more reactive secondary amines, NHR<sub>2</sub>, give predominantly the 2,6-bis-isomer, N<sub>4</sub>P<sub>4</sub>Cl<sub>6</sub>(NR<sub>2</sub>)<sub>2</sub>, the less reactive ones a mixture of 2,4- and 2,6-isomers, apparently similar to results obtained with primary amines, NH<sub>2</sub>R.

(c) Bis(dichlorophosphino)-, (Cl<sub>2</sub>P)<sub>2</sub>NR, bis(dichlorophosphinyl)-, [Cl<sub>2</sub>P(O)]<sub>2</sub>NR, bis(dichlorophosphinothiyl)-amines, [Cl<sub>2</sub>P(S)]<sub>2</sub>NR and mixed derivatives

The aminolysis, especially with NHMe<sub>2</sub>, of the above compounds has been studied by Keat and co-workers (14-17). As with N<sub>3</sub>P<sub>3</sub>Cl<sub>6</sub> (1) and N<sub>4</sub>P<sub>4</sub>Cl<sub>8</sub> (2), it follows a predominantly nongeminal reaction path, although geminal isomers are accessible in some cases by other reaction routes. In the case of nongeminal bisdimethylamino-derivatives, both *d,l*- and *meso*-forms have been observed. The results can be summarised as below.

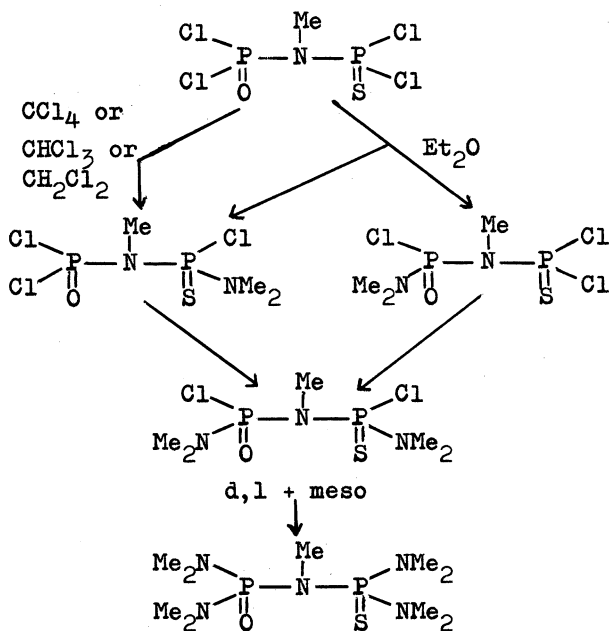
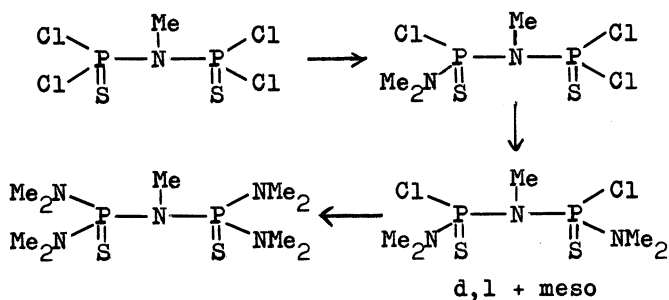
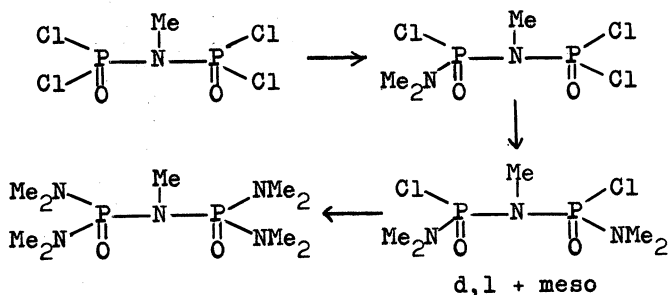
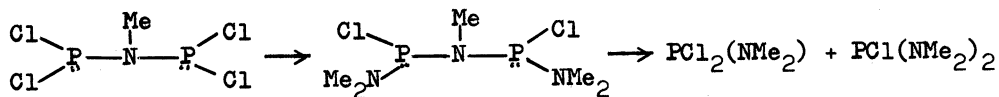

To explain the preferential aminolysis of the phosphinothioyl centre in non-donor solvents Keat and coworkers (16) postulate an intramolecular effect.

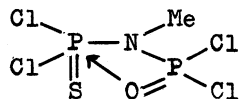

This preferential activation would be absent or reduced in a donor solvent such as  $\text{Et}_2\text{O}$ , and hence the 'normal' order of reactivity  $\text{RP}(\text{O})\text{Cl}_2 > \text{RP}(\text{S})\text{Cl}_2$  restored. This can be seen in the mixed cyclodiphosphazane (where this type of interaction is not possible) and where monoaminolysis takes place exclusively at the phosphinyl centre both in  $\text{CH}_2\text{Cl}_2$  and in  $\text{Et}_2\text{O}$ .

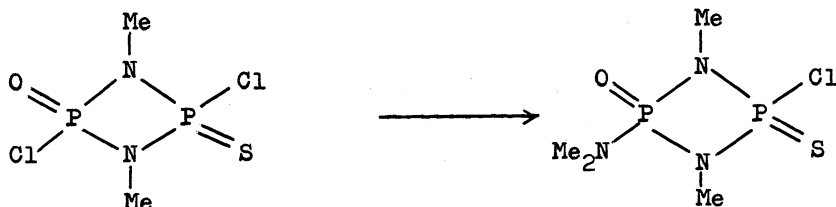

In the dimethylaminolysis of the mixed compound,  $\text{Cl}_2\text{P}(\text{O})\text{NMePCl}_2$ , (17), kinetic control gives initial substitution at the phosphino group,  $-\text{PCl}_2$ . The compound then rearranges to the thermodynamically more stable product with the  $\text{NMe}_2$  group at the phosphinyl centre,  $-\text{P}(\text{O})\text{Cl}_2$ .

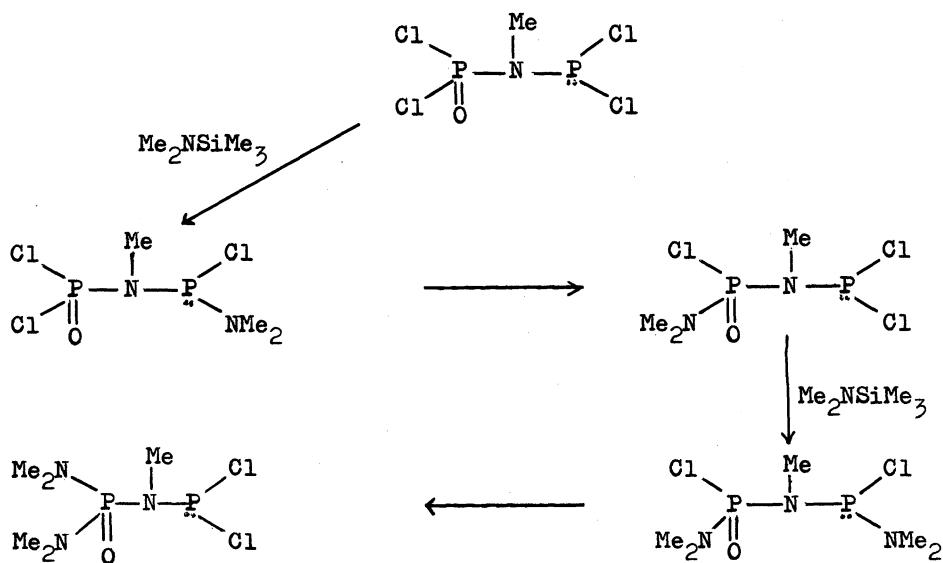

Similar transfer reactions occur intermolecularly in mononuclear phosphorus compounds (17).

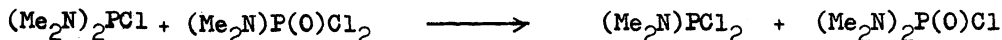

#### ALCOHOLYSIS AND THIOALCOHOLYSIS

The above reactions have received less attention than aminolysis. The reactions of  $\text{N}_3\text{P}_3\text{Cl}_6$  (1) with phenol (18, 19) *p*-bromophenol (18) and trifluoroethanol (20) proceed by a nongeminal pathway.

On the other hand, thioalcoholysis proceeds exclusively geminally,  $\text{N}_3\text{P}_3\text{Cl}_{6-n}(\text{SR})_n$  (21,22). In earlier studies (21) bis-, tetrakis- and hexakis- derivatives ( $n = 2, 4, 6$ ) were isolated together with traces of tris ( $n = 3$ ) from the reactions of  $\text{N}_3\text{P}_3\text{Cl}_6$  (1) with sodium alkanethiolates. Very recently the reaction of  $\text{N}_3\text{P}_3\text{Cl}_6$  (1) with sodium ethanethiolate in ether was reinvestigated (22). The predominance in the reaction mixture of geminal bis-, tetrakis- and hexakis-derivatives was confirmed but all the other geminal products were isolated as well in the yields stated. No trace of nongeminal isomers was detected.

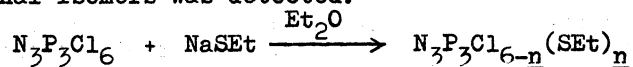

yields (%):  $\underline{n} = 1$  (3.0), 2 (67.0), 3 (1.0), 4 (10.6), 5 (2.9), 6 (4.5). Similar observations were made for the reaction

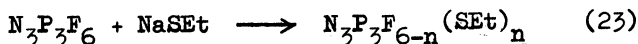

The tetramer system is again less well investigated. No systematic studies on partial alcoholysis appear to have been done.

Partial thioalcoholysis has received some attention. The major product is the 2,2,6,6-tetrakis-derivative,  $\text{N}_4\text{P}_4\text{Cl}_4(\text{SR})_4$  (24). Again recently (22) other minor products, including isomers, all based on a geminal pathway, were isolated from the reaction

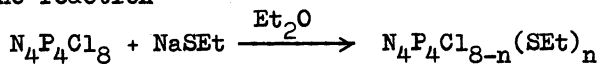

Yields (%):

$\underline{n} = 1$  (0), 2 (18.2)

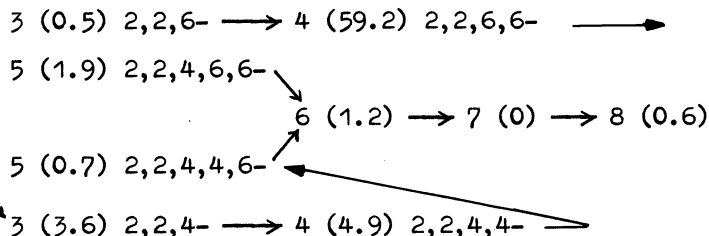

#### REACTIONS WITH BIFUNCTIONAL REAGENTS

It is convenient to discuss the reactions of all bifunctional reagents,  $\text{HX}-\text{YH}$ , together. These reagents can in principle undergo four types of reactions with phosphorus compounds:

- (1) both ends of the reagent attack the same phosphorus centre to give a spiro compound

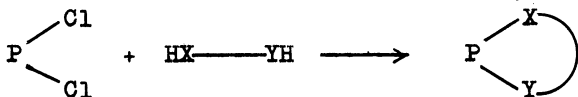

- (2) the two ends of the reagent attack different phosphorus centres in the same molecule.

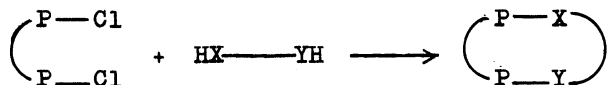

- (3) the two ends of the reagent attack phosphorus centres in different molecules

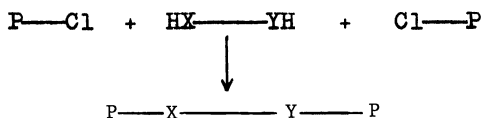

- (4) only one end of the reagent is utilised



Most of the work with bifunctional reagents has been carried out with diols ( $\text{X} = \text{Y} = \text{O}$ ), diamines ( $\text{X} = \text{Y} = \text{NH}$  or  $\text{NMe}$ ), or hydroxyamines ( $\text{X} = \text{NH}$ ,  $\text{Y} = \text{O}$ ).

For the purposes of this survey I will restrict myself largely to phosphazene and phosphazane substrates.

The reactions of aromatic diamines have been examined (25, 26) thus, e.g., with ortho-phenylenediamine one, two or three residues can be introduced.

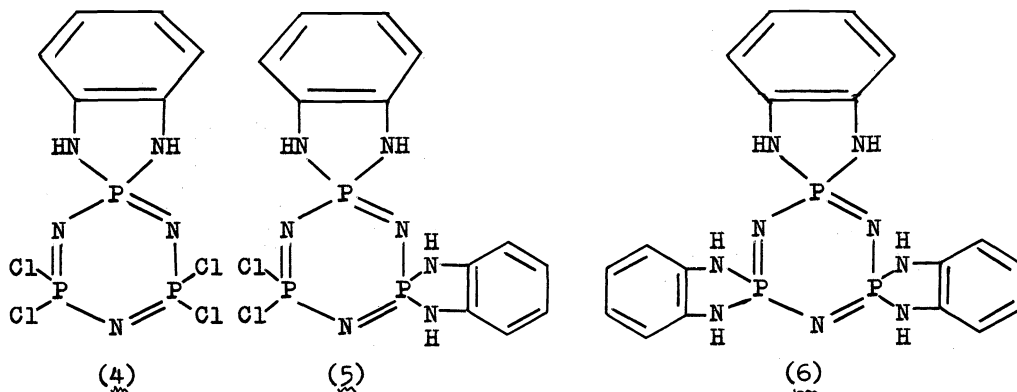

All possess the expected spiro-structure (reaction 1).

Becke-Goehring and Boppel (27) reported the reactions of the same phosphorus compound,  $N_3P_3Cl_6$  (1), with the aliphatic diamines,  $H_2N(CH_2)_nNH_2$  ( $n = 2, 3$  and 4). These workers proposed ansa-structures (7) (reaction 2) for the products, e.g.,

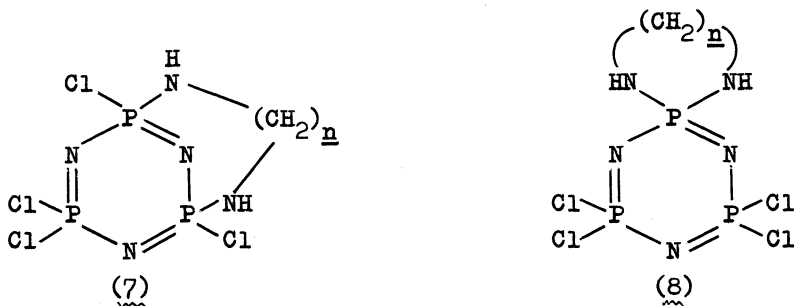

These structures (7) were disproved by us in favour of those of spiro-compounds (8) (reaction 1) (28,29). Chemical and spectroscopic evidence for the structure of these compounds was conclusively confirmed by an X-ray crystallographic investigation of  $N_3P_3(NMe_2)_4(NHCH_2CH_2NH)$  (9) (30).

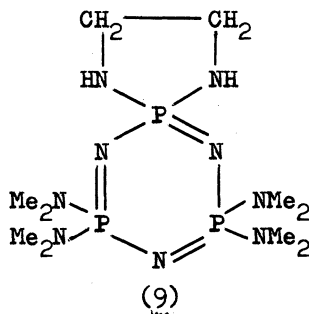

Only products containing one spiro-substituent were isolated with this reagent ( $H_2NCH_2CH_2NH_2$ ) (28). In contrast, its *N,N'*-dimethyl analogue yielded readily mono(10) and bis derivatives (11)(31).



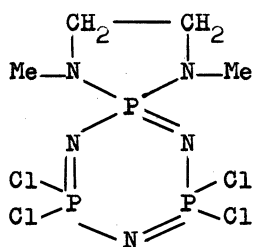

(10)

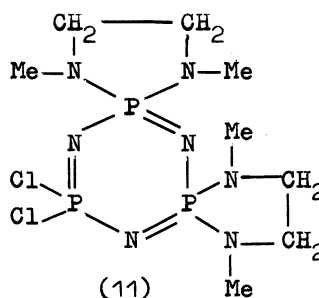

(11)

The same phosphorus compound,  $N_2P_2Cl_6$  (1) gave with ethanolamine,  $H_2NCH_2CH_2OH$ , good yields of a spiro-mono (12) and traces of two isomeric (cis-trans-relationship) spiro-bis compounds (13) (28).

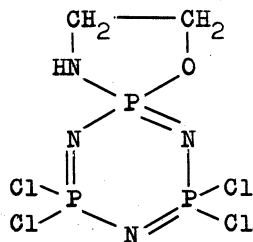

(12)

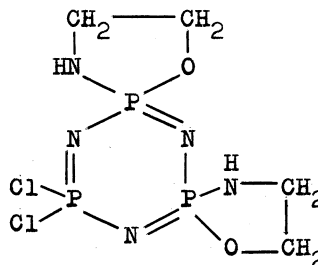

(13)

In contrast is the reaction of  $N_2P_2Cl_6$  (1) with ortho-aminophenol, where only the phosphorane (14) could be isolated (32) (see also below).

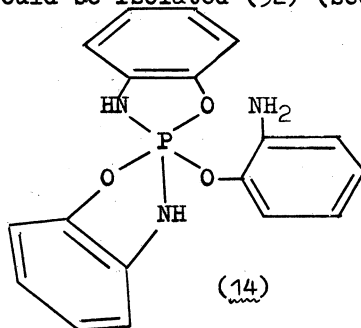

(14)

The reactions with diols have not been subjected to very systematic studies, but enough information is available to show that one, two or three diol residues can be introduced into  $N_2P_2Cl_6$  (1) to give spiro-derivatives, although not necessarily all have been isolated with the same diol (33).

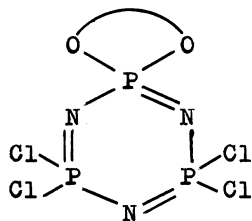

(15)

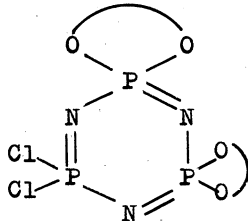

(16)

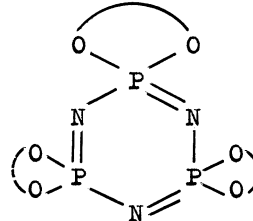

(17)

Particularly interesting is the reaction with catechol (34). Three residues are readily introduced (18) but reaction with an excess of the reagent leads to a complete degradation of the phosphazene ring and formation of a phosphorane (19).

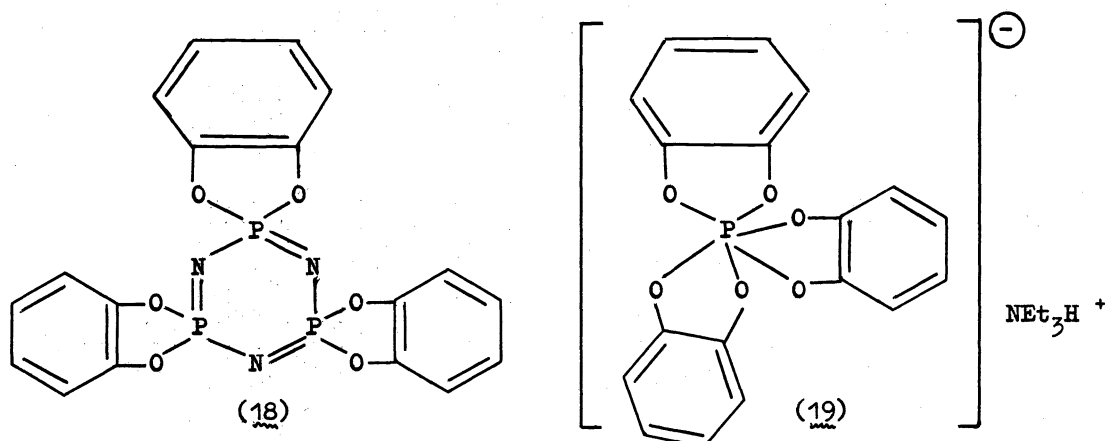

The catechol derivative of the tetramer (2) is extremely labile, giving readily the above phosphorane (19). Here, as in other reactions, we note the greater reactivity of the tetramer,  $N_4P_4Cl_8$  (2), compared with that of the trimer,  $N_3P_3Cl_6$  (1).

The catechol phosphazene (18), its naphthalene analogue (20), a thio-analogue (21) and the ortho-phenylene diamine derivative (6) all cleave readily with ortho-aminophenol to give the same phosphorane (14) (32).

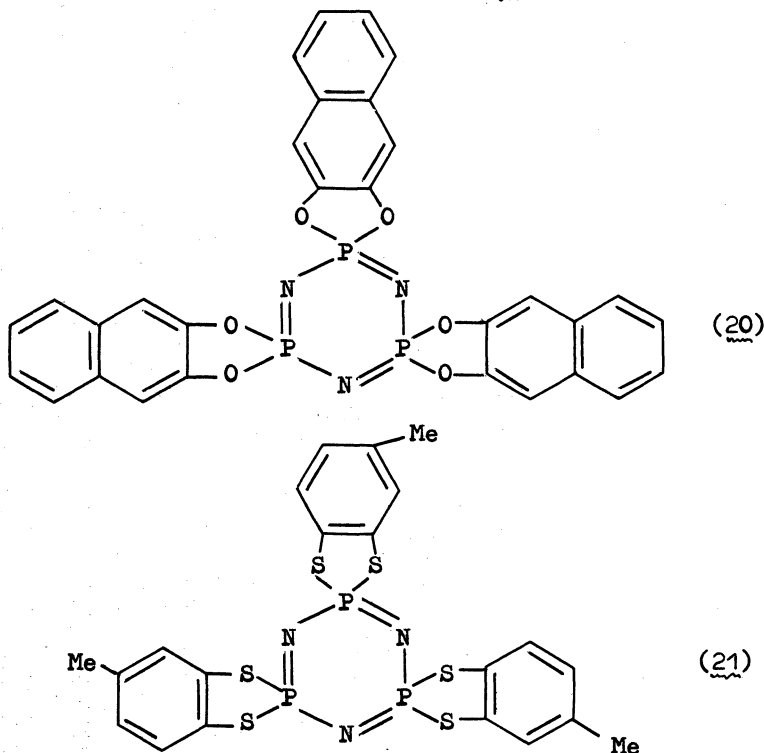

The stability of six-membered (22) and seven-membered spiro-compounds (23) [and of non-spiro compounds, e.g.,  $N_3P_3(OPh)_6$ ], towards the same reagent (32) provides an interesting contrast.

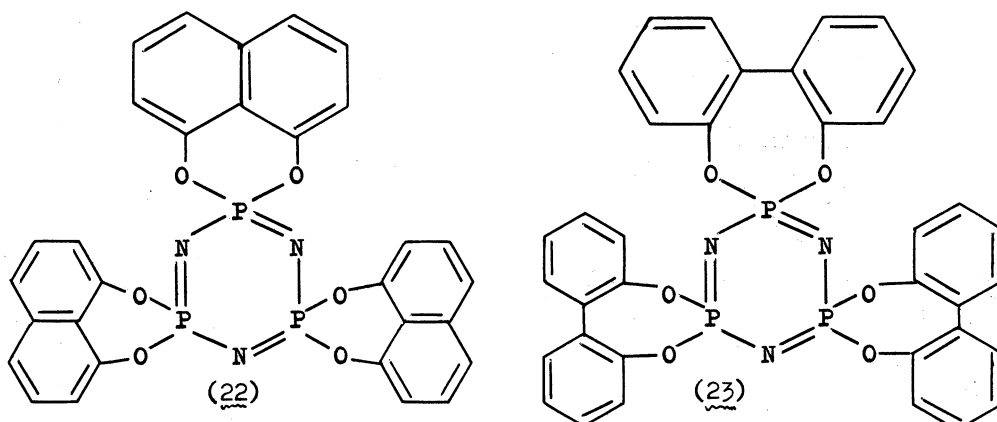

Tetramer derivatives of these same two aromatic diphenols have also been prepared (32).

Whilst, in view of Westheimer's work (35) the stability of six- and higher-membered ring spirophosphazenes is perhaps not unexpected, the stability of the ortho-phenylenediamine derivative (6) towards an excess of the diamine is noteworthy, as is its ready cleavage by ortho-aminophenol. One thus has to explain the order of chemical stability of cyclophosphazenes towards an excess of the bifunctional reagents from which they are formed.

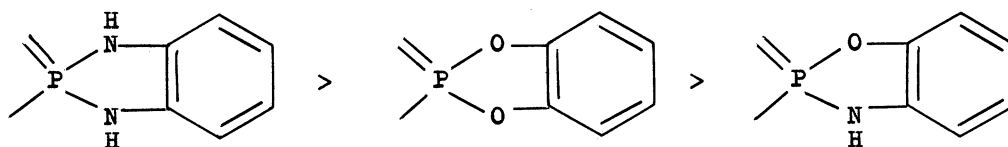

Allcock and coworkers (36) have postulated that attack by nucleophiles on the second and third species gives rise to the intermediates

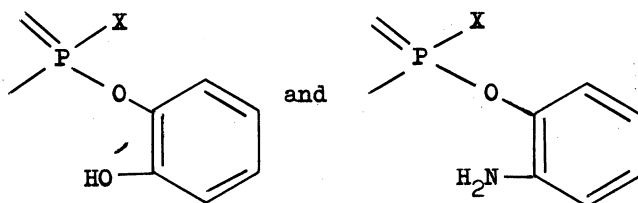

respectively.

The common feature these intermediates share is that they still contain a P-O-C bond, a structural feature absent in the ortho-phenylenediamine derivative (6). A possible explanation of this stability might be that further reaction of derivative (6) with ortho-phenylenediamine would require a trigonal bipyramidal intermediate with a nitrogen rather than the more electronegative oxygen in an apical position. Whilst Westheimer (35) has been able to give a satisfying picture in terms of pseudorotation and release of ring strain for the five-membered ring phosphates, e.g.,

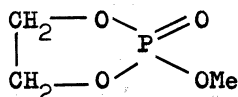

the same elegance to explain the above phenomena in cyclophosphazene chemistry is as yet lacking.

The above findings with aromatic bifunctional reagents must be borne in mind when comparing these with their aliphatic analogues, where a somewhat different order of reactivity seems to prevail.

The  $^{31}\text{P}$  n.m.r. spectrum of  $\text{N}_2\text{P}_2\text{Cl}_6$  (1) derivatives with ethylene-diamine and ethanolamine (28) show some anomalous chemical shifts (see below) of the spiro phosphorus centre compared with those of phosphorus with acyclic

ligands). These shift anomalies disappear when reagents are used, which give six- $\{N_3P_3X_4[NH(CH_2)_3NH]\}$ , or higher-membered  $\{N_3P_3X_4[NH(CH_2)_4NH]\}$  ring spiro compounds (29) rather than five-membered ring spiro derivatives.

Chemical shift values,  $\delta$ ,\* of some spirocyclic cyclophosphazene and some analogues with non-spiro structures

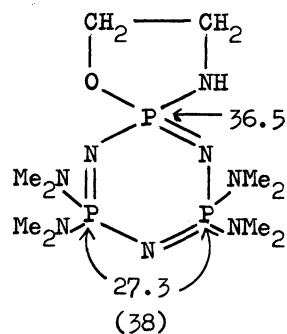
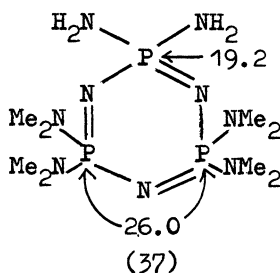
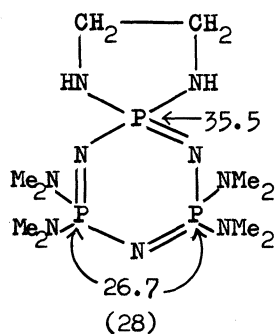
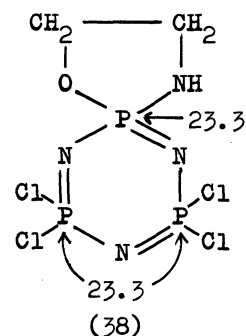
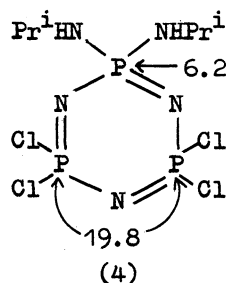
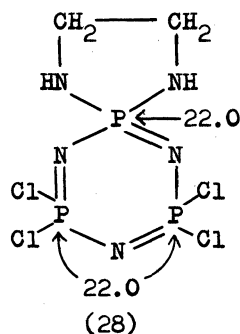

\* $\delta$  relative to 85%  $H_3PO_4$  (external), downfield is positive.

We must now examine why with some aliphatic bifunctional reagents up to three residues can be readily introduced into  $N_3P_3Cl_6$  (1) whilst with others only derivatives with one such residue can be isolated. With the latter group of reagents, the reaction does not stop with the introduction of one residue; instead, it proceeds to give resinous materials. These are, in all probability, cross-linked materials (reaction 3), which are also often observed in the reactions of chlorocyclophosphazenes with primary amines, e.g.,  $NH_2Et$  (2,7). This itself gives us a clue to the mechanism of the resin formation. If, in the case of the bifunctional reagents, cross-linking (reaction 3) occurred because of their  $\alpha, \omega$ -bifunctionality, it is not apparent why, e.g., diols and  $N, N'$ -dimethylethylenediamine should behave differently from, e.g., ethylenediamine.

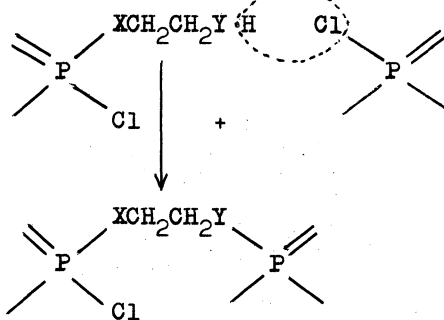

Taking these observations in conjunction with those on primary amines, one

concludes that in all probability, it is the P-N-H moiety which is responsible for the resin formation (see also section on bicyclic compounds below). This P-NH grouping is rather acidic and will readily react by a proton abstraction mechanism and I believe that it is this structural unit which is responsible for the resin formation, e.g.,

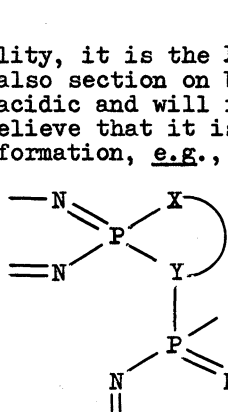

Thus with ethylenediamine (2 N-H) only mono-derivatives have been found (28, 38), with ethanolamine (1 N-H), traces of bis-derivatives can be isolated (28, 38), whilst with ethylene glycol, its derivatives (33), and with N,N'-dimethylethylenediamine (no N-H) (31), higher substitution is readily attained.

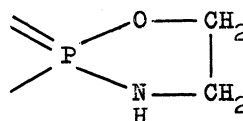
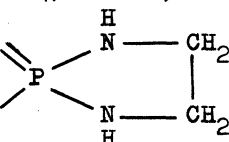

One is therefore tempted to speculate that N-methyl ethanolamine, MeHNCH<sub>2</sub>CH<sub>2</sub>OH, should give rise to mono-, bis-, and tris-spiro derivatives. Apart from the effect of the P-N-H group it remains to be discovered to what an extent five-membered ring spiro structures cause not only differences in chemical shifts of the phosphorus nuclei but also differences in chemical behaviour. We are currently investigating larger diamines, H<sub>2</sub>N(CH<sub>2</sub>)<sub>n</sub>NH<sub>2</sub> (n = 3, 4) (29). It should again be noted that the only authenticated phosphazene ring cleavages by bifunctional reagents occur with catechol (34) and *ortho*-aminophenol (32), both of which give five-membered rings with phosphorus. An interesting question also remains to what an extent the conformation of the lone pairs of electrons of the oxygen and nitrogen atoms (1, 39-42) in the spiro ring affect the chemical and physical properties of these compounds. Obviously, further X-ray crystallographic data on spiro compounds would be highly desirable.

Before closing this section I would like briefly to examine the behaviour of some cyclodiphosphazanes. We have seen that on careful examination (28, 38) the reports of *ansa*-structures in cyclotriphosphazatrienes (two phosphorus atoms in the same molecule spanned by a bifunctional reagent) proved to be incorrect (27).

However, some *bona fide* examples exist in cyclodiphosph(III)azanes. The chloro compound, [ClPNCBu<sup>t</sup>]<sub>2</sub> is known to have a *cis*-structure (43). Keat and coworkers (44, 45) have shown that its two chlorine atoms, one on each phosphorus atom, can be spanned by means of the bifunctional reagents, HNMe(CH<sub>2</sub>)<sub>2</sub>NMeH, and HO(CH<sub>2</sub>)<sub>n</sub>OH (n = 2, 3) to give genuine *ansa*-type compounds. It should be noted that in the resultant products no P-N-H groupings occur.

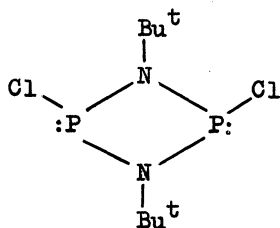

*cis*-compound

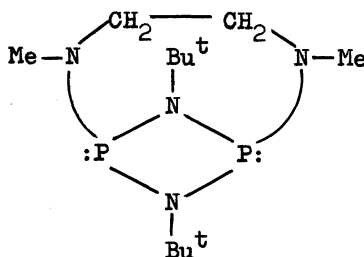

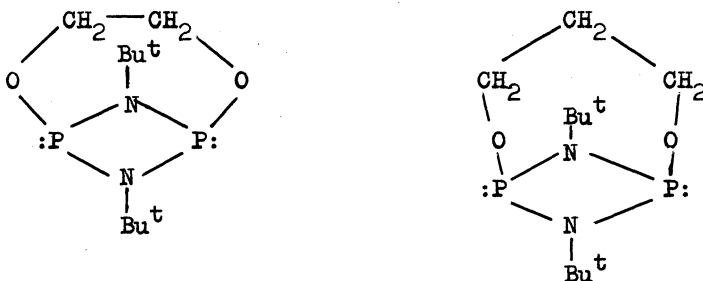

Finally, one must draw attention to the fact that the above discussion does not give a satisfying explanation of the apparent differences towards  $N_3P_3Cl_6$  (1) between related aliphatic and aromatic reagents, e.g., ethylene diamine (only mono-spiro-derivatives), ortho-phenylenediamine (mono-, bis-, tris-spiro compounds), ethanolamine (mono-, and traces of bis-spiro-derivatives), ortho-aminophenol (only ring cleavage to give spirophosphoranes), ethylene glycol (up to tris-spiro-structures, no ring cleavage reported), catechol (tris-spiro compound, which cleaves with excess of reagent to give spirophosphorane).

### BICYCLIC PHOSPHAZENES

In the previous section I discussed the reactions of bifunctional reagents. These reagents all had their twin functionality on two different atoms. In a way a primary amine,  $NH_2R$ , (or ammonia or water) has twin functionality on the same atom.

Bulloch and Keat (46), as well as Kukhar' (47), have shown that the reactions of bis(chlorophosphinyl)amines with primary amines yield cyclodiphosphazanes, i.e., act as bifunctional reagents:

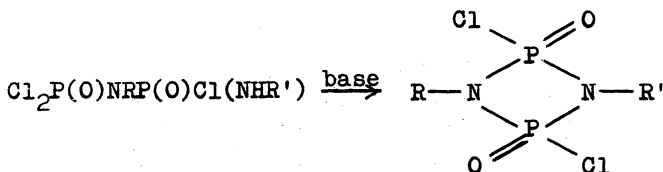

[R = R' = Me, Ph (47); R = Me, R' = Bu<sup>t</sup> (46)].

Similarly, bis(chlorophosphino)amines,  $(Cl_2P)_2NR$ , and bis(chlorophosphinothioyl)amines  $[Cl_2P(S)]_2NR$ , are cyclised by primary amines (46).

Cyclisation occurs in the thermolysis of phenylphosphonothioic diamides,  $PhP(S)(NHR)_2$ , (48), and of phosphorothioic triamides,  $P(S)(NHR)_3$ , (49), to give the cyclodiphosphazanes,  $[PhP(S)NR]_2$ , and  $[(RHN)P(S)NR]_2$  respectively. All these give rise to monocycles however. The complex spiro compound,  $P_4Cl_8(NMe)_6$ , although again the product of a reaction involving a primary amine, owes its complexity to the polyfunctionality at phosphorus (50).

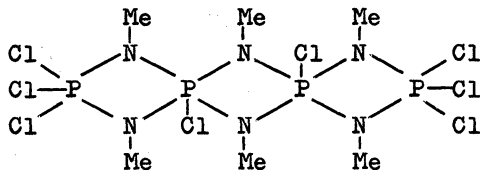

The first true bicyclic compound (26) based on the bifunctionality of a primary amine was observed by Sau when studying the reaction of 2,6-trans- $N_4P_4Cl_6(NHEt)_2$  (24) with dimethylamine (51). This reaction is markedly solvent dependent and a simplified reaction scheme is shown below.

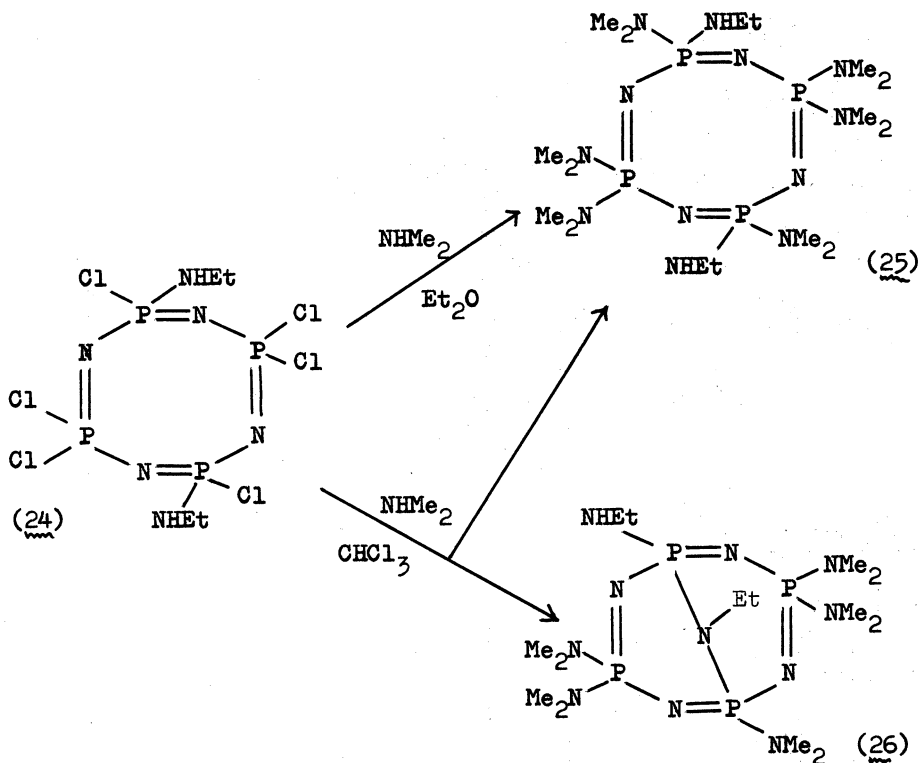

The crystal structure of this first bicycle (26) was determined by Cameron and Mannan and a 2,6-fusion confirmed (52, 53). The molecule is basket-shaped. Its original eight-membered ring peripheral P-N framework retains its phosphazene character. The bridging P-N bonds are however long and the bridgehead nitrogen is approximately pyramidal.

A generalised scheme of the reactions of  $\text{N}_4\text{P}_4\text{Cl}_6(\text{NHR})_2$  with amines giving monocycles, bicycles and resins is given below.

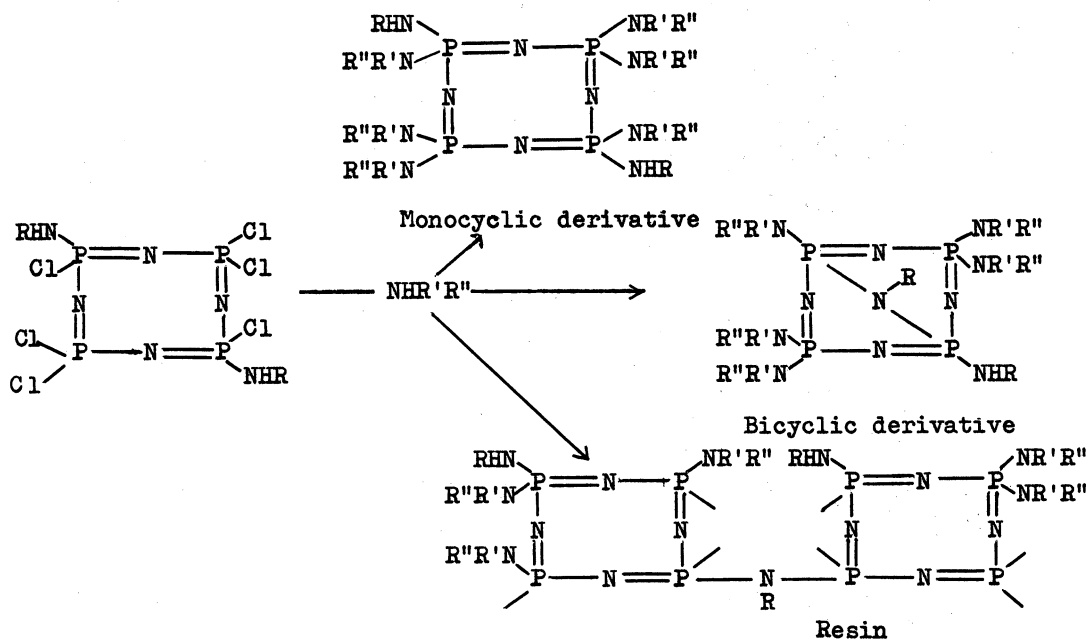

Subsequent to the discovery of the above bicycle a series of related bicyclic phosphazenes was isolated,  $N_4P_4(NMe_2)_5(NHR)(NR)$  [ $R = Me$  (54),  $Pr^i$  (54)], and  $N_4P_4(NHR)_6(NR)$  [ $R = Me$  (55),  $Et$  (51)], and others,

$N_4P_4(NMe_2)_5(NHR)(NR)$  ( $R = Bu^i$ ,  $CH_2Ph$ ),  $N_4P_4(NMe_2)_5(NHBU^t)(NEt)$ , were observed in solution (54).

The crystal structure of two further examples of this type were studied, that of  $N_4P_4(NHMe)_4(NMe)$  (56), and most recently that of  $N_4P_4(NMe)_4(NHMe)(NMe)$  (57). The latter structure, a particularly accurate one, was found to be a hydrate,  $[N_4P_4(NMe)_4(NHMe)(NMe)]_2 \cdot 2H_2O$ .

The effect of a variety of solvents, as well as that of added tertiary base, on the reaction of  $N_4P_4Cl_6(NHEt)_2$ , was studied in some detail, as was the nature of  $R$  in the reaction of 2,6- $N_4P_4Cl_6(NHR)_2$  with dimethylamine in chloroform (54). Branching at the  $\alpha$ -carbon atom of  $N_4P_4Cl_6(NHR)_2$  (e.g.,  $R = Pr^i$ ,  $Bu^t$ ,  $Ph$ ), seems to inhibit bicycle formation. Only if such branching was absent in  $R$  was bicycle formation observed.

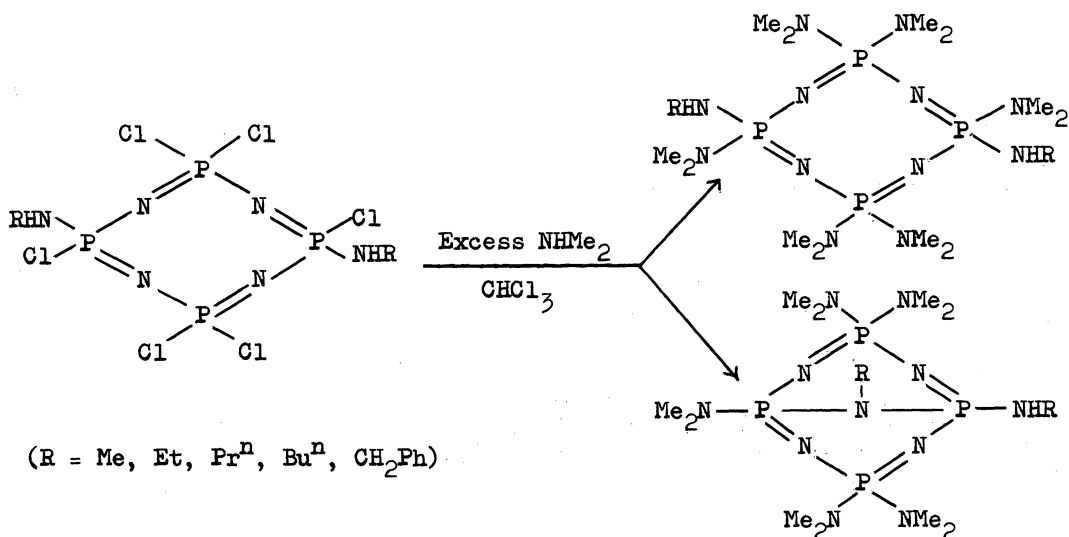

Some features of these bicyclic compounds are worth special mention. The effect of shift reagents (51) is much greater on them than on the related eight-membered monocycles, the point of interaction being the bridgehead nitrogen, which is also, at least in some cases, the site of greatest basicity towards the proton.

Some amino groups, e.g.,  $NMe_2$ ,  $NHEt$ ,  $NHMe$ , show much subtler chemical shift differences in  $^1H$  n.m.r. spectroscopy (51, 54, 55) than the same groups in related monocycles based on  $N_3P_3$  or  $N_4P_4$  skeletons, where often some chemically different environments are not resolved at 100 MHz or even 220 MHz. There is also some indication that reaction with bulky nucleophiles (see below) is somewhat easier with the bicycle than with the  $N_3P_3$  and  $N_4P_4$  monocycles.

Work to date suggests that two primary amino groups (P-NHR) are necessary at  $P_2$  and  $P_6$  for bicycle formation (54). Hence a likely reaction mechanism is loss of  $HCl$  from one site followed by N-H addition across the  $P=N$  bond generated.

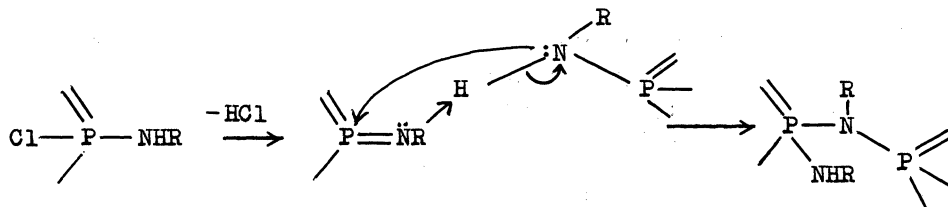



The existence, structure and reactions of related monophosphorus species  $R_2N-P \begin{matrix} \swarrow NR \\ \searrow NR \end{matrix}$  has been discussed elsewhere (40). One apparent exception to the observation that two P-NHR groups must be present for bicycle formation to occur has been reported. In the reaction of  $N_4P_4Cl_8$  with dibenzylamine,  $NH(CH_2Ph)_2$ , a bicycle,  $N_4P_4[N(CH_2Ph)_2]_6(NCH_2Ph)$ , was isolated in small yield (58).<sup>2</sup> Whilst dibenzylamine is known to disproportionate under drastic conditions (cf. 59)

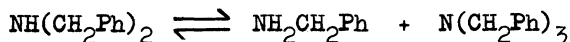

it seems unlikely that this would be the cause of the above bicyclic compound formation. It may be that a N-dealkylation process by the phosphorus halide is involved in the bridge formation. Such N-dealkylations have been observed, usually however, under drastic reaction conditions, e.g.,

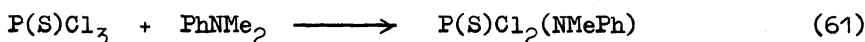
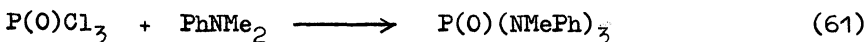
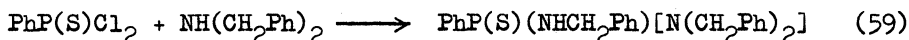
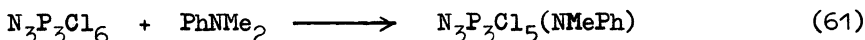
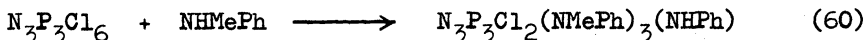

Remarkable is the complete replacement of chlorine atoms in the above bicycle by  $N(CH_2Ph)_2$  residues, when in the related monocycles  $N_3P_3Cl_6$  (62) and  $N_4P_4Cl_8$  (58) the maximum degree of replacement by this amine is so far observed is  $N_3P_3Cl_4[N(CH_2Ph)_2]_2$  and  $N_4P_4Cl_4[N(CH_2Ph)_2]_4$ .

I have referred elsewhere (40) to the formation of a 2,4-fused bicycle,  $N_4P_4F_6(NSN)$ , from a fluorinated precursor (63).

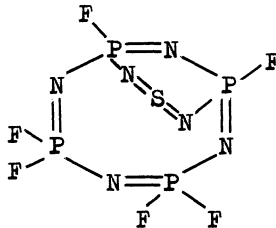

### MOLECULAR REARRANGEMENTS

Perhaps the best known of these in phosphorus chemistry is the Arbuzov reaction (64),



which involves the migration of an alkyl group from oxygen to phosphorus. In this process the coordination number of one oxygen atom is decreased from two to one, that of phosphorus increased from three to four.

In phosphorus-nitrogen chemistry the migration of alkyl and silyl groups has been observed, as has been that of protons. The first type is irreversible, the second and third types are reversible. Proton migration will be discussed in a separate section under tautomerism.

An example of the Arbuzov reaction, particularly relevant to this lecture, comes from cyclodiphosph(III)azane chemistry. Both geometric isomers of the alkoxy-derivative,  $[(MeO)PNBu^t]_2$ , were converted on treatment with methyl iodide (or under more forcing conditions without this reagent) to the corresponding mono- and di-rearranged products (45).

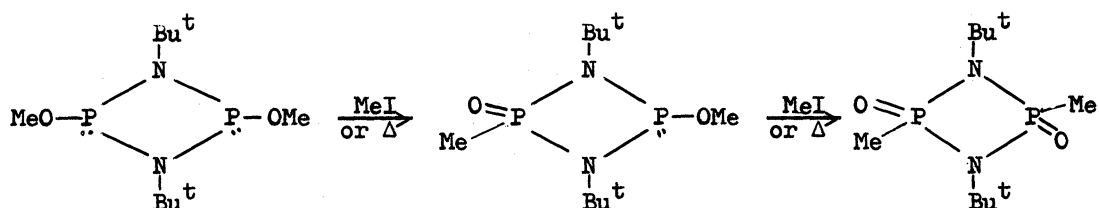

In the alkoxyphosphazene-oxophosphazane rearrangement first discovered by Fitzsimmons and Shaw (65), *e.g.*,

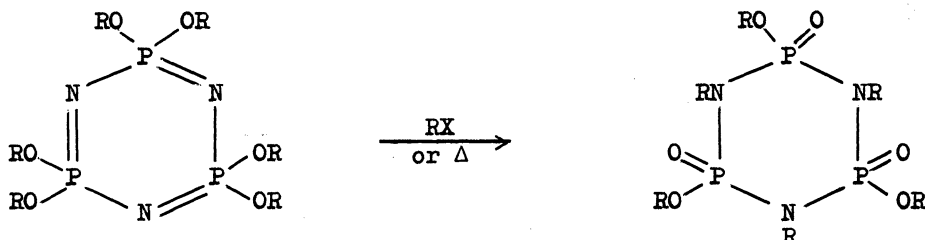

an alkyl group, R, migrates irreversibly from oxygen to nitrogen, whose coordination numbers decrease by one and increase by one respectively, that of phosphorus remaining unchanged. This rearrangement can be carried out thermally or by alkyl halide, R'X, catalysis (65). In the latter case, if the alkyl group in the alkyl halide is different from that of the alkoxyphosphazene, (R ≠ R') 'mixed' derivatives are obtained and R' is found attached to the nitrogen atom of the product.

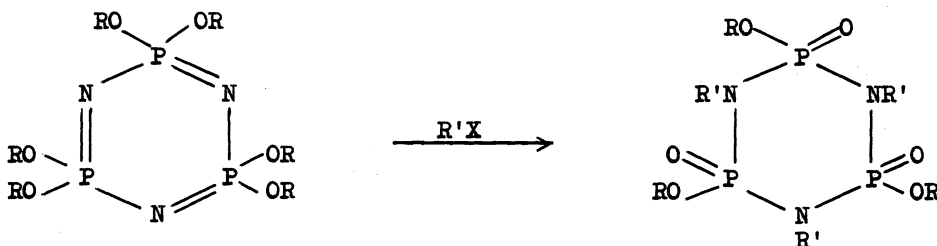

The same type of mixed derivative had been observed earlier in alkyl halide catalysed traditional Arbuzov reactions (64), and very recently (45) in cyclodiphosph(III)azanes.

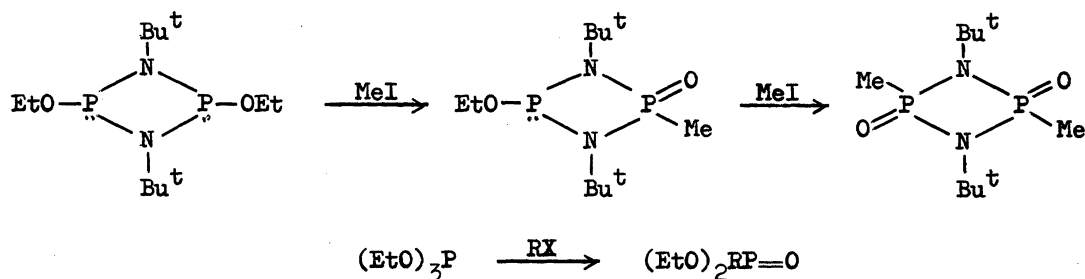

The Arbuzov reaction is believed to go through a quasi-phosphonium intermediate and an example of this,  $[\text{Ph}_2\text{MeP}(\text{OCH}_2\text{CMe}_3)]^+\text{Br}^-$ , has just been crystallographically characterised (66).

The alkoxyphosphazene-oxophosphazane rearrangement has been examined in some detail for the methoxycyclophosphazenes,  $\text{N}_3\text{P}_3(\text{OMe})_6$  (65, 67), and  $\text{N}_4\text{P}_4(\text{OMe})_8$  (65, 67). The former gives one,  $\text{N}_3\text{Me}_3\text{P}_3\text{O}_3(\text{OMe})_3$ , the latter two isomeric rearrangement products,  $\text{N}_4\text{Me}_4\text{P}_4\text{O}_4(\text{OMe})_4$ . Starting materials and products have been examined by n.m.r. spectroscopy in solution (67) and all except  $\text{N}_3\text{P}_3(\text{OMe})_6$ , by X-ray crystallography in the solid state (*cf.* 40). Whilst

$^{31}\text{P}$ ,  $^1\text{H}$  and  $^{13}\text{C}$  n.m.r. spectroscopy shows two environments each for phosphorus, NMe and OMe, in the trimer,  $\text{N}_3\text{Me}_2\text{P}_3\text{O}_3(\text{OMe})_3$ , only one environment each was observed in the tetramer derivatives,  $\text{N}_4\text{Me}_4\text{P}_4\text{O}_4(\text{OMe})_4$ .

Crystallographic studies show that in these alkoxyphosphazenes and oxophosphazanes, bond lengths and angles change in a predictable manner. On passing from the phosphazene to the phosphazane, the P-N bond lengths increase and the NPN angles decrease, whilst the exocycle  $\text{O}=\text{P}-\text{OMe}$  angles increase. The rearranged trimer has a trans-structure and adopts a pronounced boat conformation. Both the tetramer derivatives are highly puckered and have 2-trans-4-cis-6-trans-8-, and 2-cis-4-trans-6-trans-8- structures, respectively (see ref. 40).

Other examples of this rearrangement

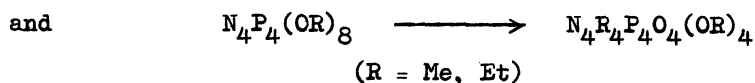
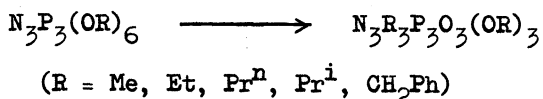

have been reported, as have been mixed derivatives (65)

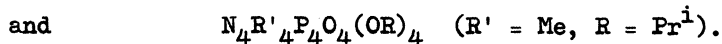
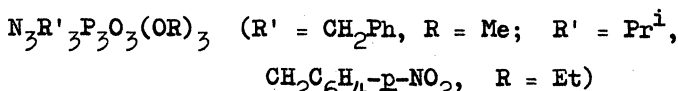

Fluoroalkoxy and aryloxyphosphazenes however do not undergo this rearrangement. Reasons for this have been discussed elsewhere (65). Instead, the former undergo a reversible change of ring size with trimer and tetramer derivatives predominating (68), e.g.,

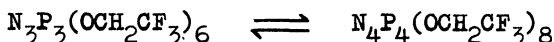

It seems probable that aryloxy-derivatives behave in a related fashion.

Acyclic alkoxyphosphazenes also undergo the oxophosphazane rearrangement. Thus, Kirsanov and coworkers (69) reported the thermal reaction, e.g.,

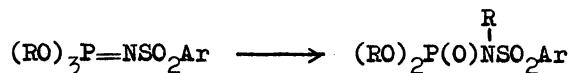

as did Pudovik and coworkers (70).

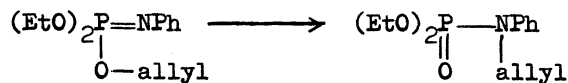

The alkyl halide catalysed reaction is also well documented for acyclic phosphazenes, e.g., Kabatschnik and Gilyarov (71) showed that

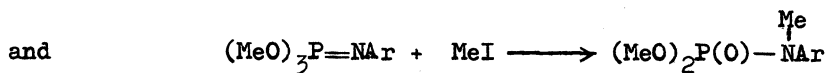
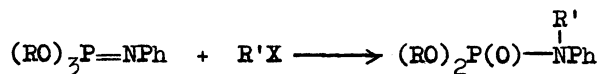

These reactions remind one of the well known Fischtschimuka rearrangement (72),



O → O as well as O → N migrations, thermal as well as catalytic, have been observed in more complex systems, e.g.,

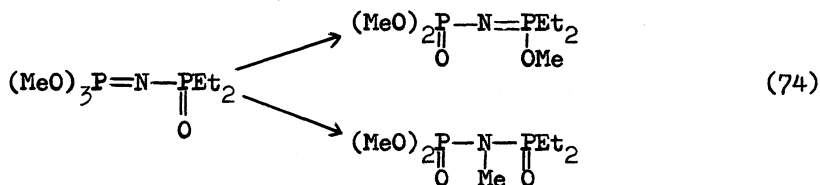
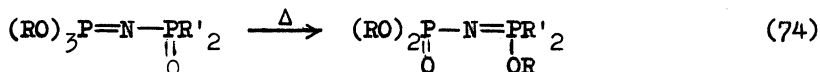
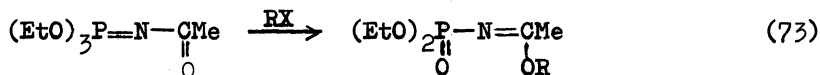

The polymeric alkoxyphosphazenes,  $[\text{NP}(\text{OR})_2]_n$  also undergo a thermal rearrangement to the corresponding oxophosphazenes  $[\text{NRP}(\text{O})(\text{OR})]_n$ . Thus alkyl shifts O → N are well documented.

Whilst however proton and silyl shifts N → N appear to have received some attention (see below), the corresponding alkyl migrations seem to have been neglected.

Thus under suitable structural and environmental conditions one could visualise a N → N alkyl group migration where one phosphazene centre was destroyed whilst another, less nucleophilic one, was created, e.g.,

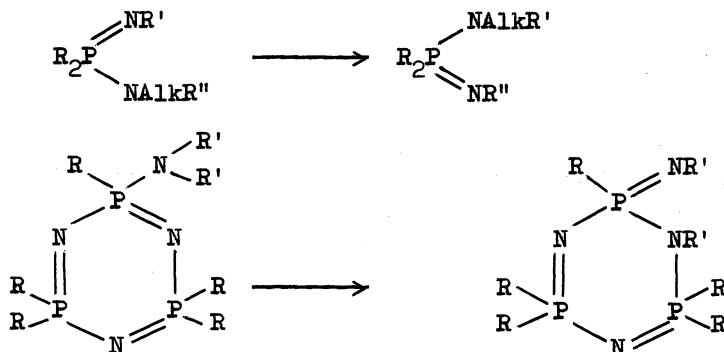

Silyl group migrations have received a good deal less attention. Silyl groups behave less like alkyl, more like acyl groups. They also have a very strong affinity for oxygen.

Riesel and coworkers (75) have investigated the acyclic systems:

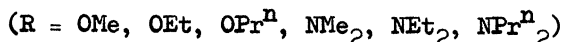
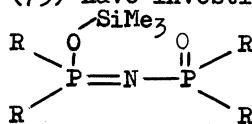

These contain three potential sites for the  $\text{Me}_3\text{Si}$  group, two oxygen atoms and one nitrogen atom. No evidence could be added for the migration O → N in this system to give a phosphazane

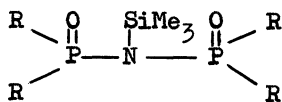

Instead, a rapid  $O \rightarrow O$  exchange between the two phosphazene structures was observed.

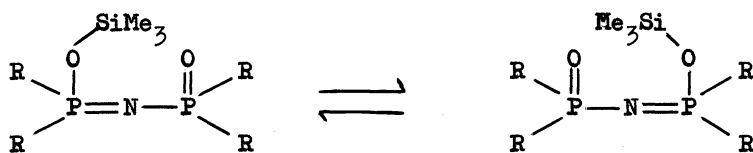

Kabatschnik and coworkers (76) came to the same conclusion as Riesel and coworkers (75).

The above is in contrast to the rapid  $O \rightleftharpoons N$   $Me_3Si$  exchange in organic acid amides. Thus an equilibrium of the  $O$  and  $N$  silyl derivatives of the aromatic acid amides was postulated, based on n.m.r. spectroscopic evidence (77).

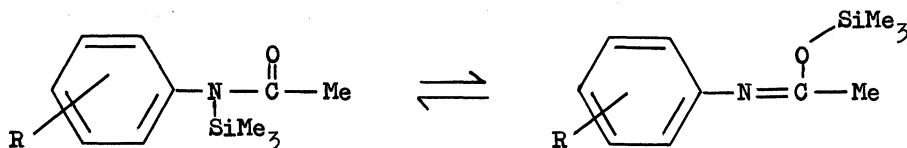

The hypothesis that it was a genuine  $Me_3SiO \rightleftharpoons NSiMe_3$  shift, rather than hindered rotation about the  $C=N$  bond, was strengthened by similar observations in a cyclic amide system (77).

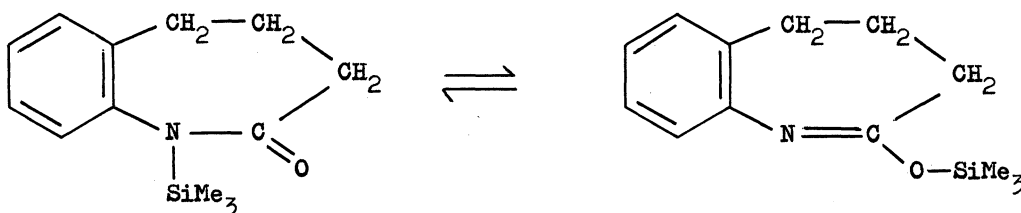

A derivative,  $Me_3Si-O-PCl_2=N-SiMe_3$ , with  $Me_3Si$  attached to oxygen as well as to nitrogen has been reported by Glemser and his coworkers (78).

It should be noted however that the starting material, a phosphazene, for the products studied by Riesel (75) has a proton attached to nitrogen, whilst the product, a phosphazene, has the  $Me_3Si$  group attached to oxygen.

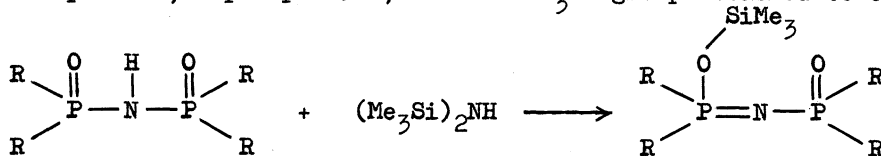

A similar observation has been made by Vilceanu and Schulz (79) in cyclophosphazene chemistry, although the structures were not rigorously established.

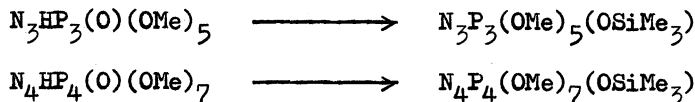

The above phenomenon seems fairly widespread in organic chemistry, e.g., nucleosides, where  $NH$  starting materials give rise to  $OSiMe_3$  products (80).

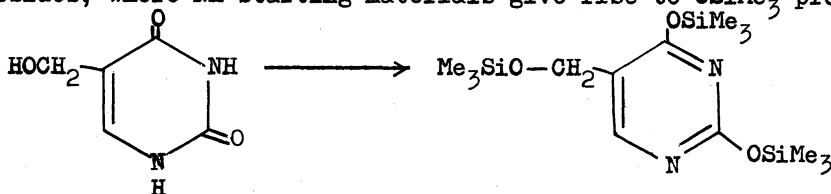

Generally speaking, organic and inorganic acid amides with structural units  $(\text{Me}_3\text{Si})_2\text{N}-$  and  $\text{M}=\text{O}$  appear to be absent, the isomeric  $\text{Me}_3\text{Si}-\text{N}=\text{O}$ , and  $\text{Me}_3\text{SiO}-\text{M}$  forms being preferred, e.g.,

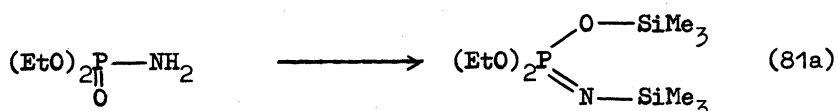
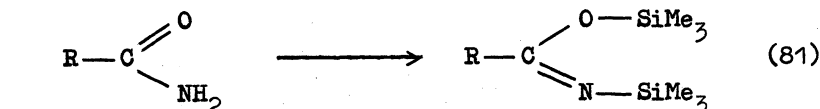

A very recent paper by Neilson and coworkers (82) allows some generalisations to be made for silylated four-coordinate phosphorus compounds.

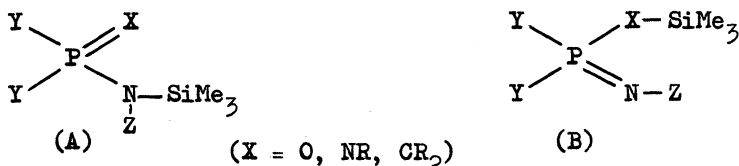

With few exceptions, when  $\text{X} = \text{O}$  or  $\text{CR}_2$ , the right-hand form (B) is the only one observed. For  $\text{X} = \text{NR}$  the situation is more complex.

If the substituents Y are electron-releasing and the two structures (A) and (B) are identical, a rapid equilibrium between the two may be observed at ambient temperature. If the substituents Y are electron-withdrawing no rapid (1,3)-silyl shifts are observed. If (A) and (B) are non-identical that isomer alone is observed (whether it requires a rearrangement or not) which has the bulkiest substituent on the phosphazene nitrogen, e.g.,

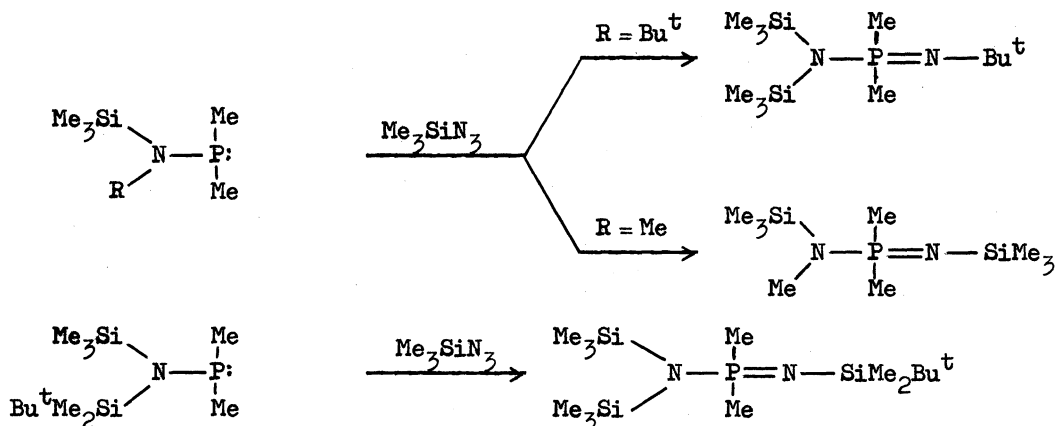

#### TAUTOMERISM

Perhaps one of the best known examples of tautomerism in phosphorus chemistry is that of phosphorous acid (83).

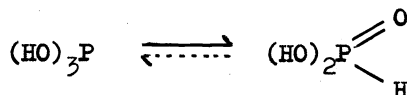

There is little reliable evidence for the three-coordinated tautomer, although it is postulated as a reaction intermediate. The equilibrium seems to be wholly on the right-hand side, the species containing the phosphoryl group,  $\text{P}=\text{O}$ .

The evidence for most types of related compounds, e.g.,  $R_2P(OH) \rightleftharpoons R_2HP=O$  is similar.

Schmidpeter and Rossknecht (84) have examined the related aminophosphine  $\rightleftharpoons$  phosphazene tautomerism.

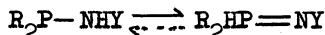

They were never able to observe spectroscopically an equilibrium; only either the aminophosphine or the phosphazene was detected. Base strengthening groups ( $R = Me$  or  $Ph$ ) were attached to phosphorus, acid strengthening groups [ $Y = SO_2CF_3$ ,  $SO_2C_6H_4Me$ ,  $P(S)(OPh)_2$ ] to the nitrogen.

Schmidpeter and coworkers (85) also observed tautomerism in cyclic compounds, giving rise for the first time to cyclophosphazenes containing P-H bonds.

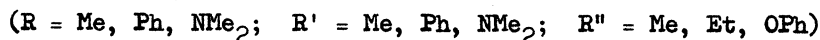
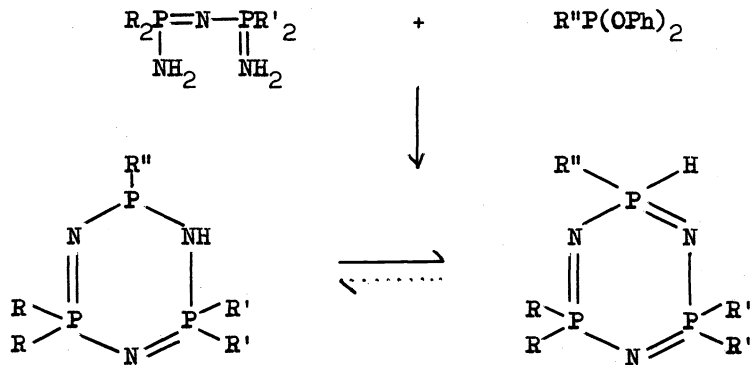

In this cyclic system only evidence for the right-hand form, the phosphazatriene, was found.

This tautomerism is similar to that of phosphorous acid (although in the acyclic system not always so markedly on the right-hand side, i.e., the form containing a four-coordinated phosphorus atom, in that a three-coordinate phosphorus species is giving rise to four-coordinate one containing a multiple bonded atom (e.g., O or N) and a P-H bond.

Another type of  $O \rightleftharpoons P$  or  $N \rightleftharpoons P$  shift has been observed by Barrans, Burgada, Mathis and Wolf and their respective coworkers (86-88). Here too, the proton shift is similar to the above examples in giving rise to P-H bonds but instead of a four-coordinate phosphorus (with a multiple bonded atom) a five-coordinate species, a phosphorane, is obtained, e.g.,

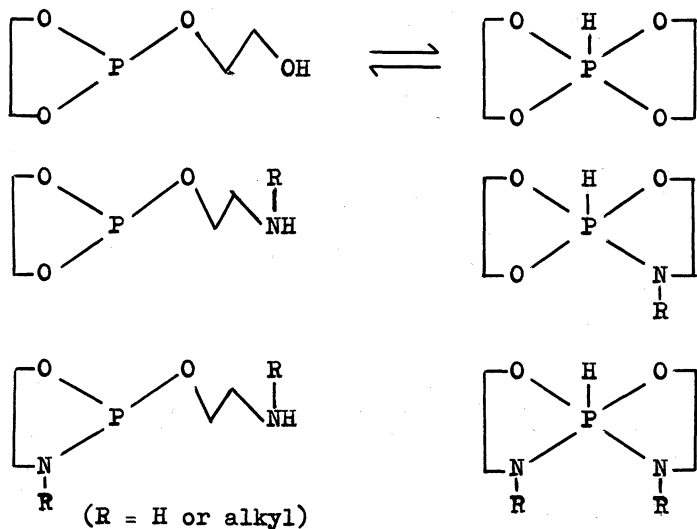

Thus in all the above examples, the phosphorus atom is directly involved, its coordination number is changed and the proton resides on it in the higher-coordinate tautomeric forms.

We now examine the tautomeric shifts  $O \rightleftharpoons N$  and  $N \rightleftharpoons N$ . Whilst none of the latter have been observed in compounds of the type  $N_3P_3R_{6-n}(NHR')_n$  to give rise to segments of the type

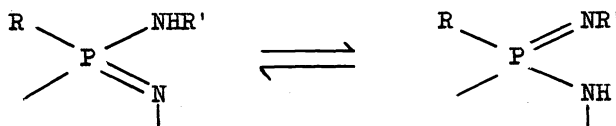

the corresponding  $O \rightarrow N$  tautomerism is tacitly assumed to be predominant.

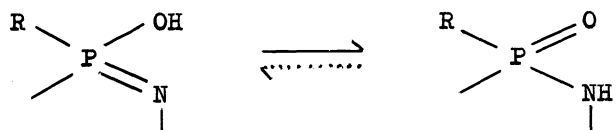

$N \rightleftharpoons N$  proton migration has however been observed when a proton passes to another phosphazene centre and generates a phosphazene centre at its point of departure. This can apply in cyclophosphazene hydrohalides, e.g.,  $N_2P_3(NHR)_6, HCl$  and  $N_4P_4(NHR)_8, HCl$ , if R is small and exchange processes make all  $^{31}P$  and relevant  $^1H$  signals equivalent at ambient temperatures. An example of this is the 2,4-trans-derivative,  $N_3P_3(NMe_2)_2(NHEt)_4, HCl$  (37). The  $^{31}P$  spectrum of its parent base,  $N_3P_3(NMe_2)_2(NHEt)_4$  is of the  $AB_2$  type (parameters as indicated).

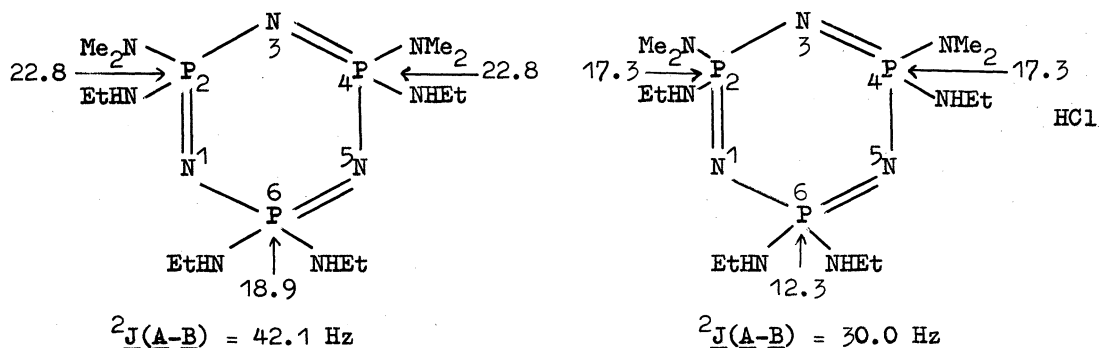

The facts that  $J(\underline{A}-\underline{B})$  is reduced in the hydrochloride and that both  $\delta_A$  and  $\delta_B$  change by about the same amount show that some protonation takes place at N(1) and N(5). As the spectrum remains of the  $AB_2$  type, it also indicates that fast proton exchange occurs between N(1) and N(5). A slow exchange would have changed the spectrum to an ABC or ABX type. The above data does not however exclude some protonation on N(3), which also seems feasible on basicity grounds.

If the substituents are bulky, the proton exchange is sufficiently slow to allow non-equivalence of otherwise chemically equivalent ring nitrogen atoms to be observed. Thus for  $N_4P_4(NHBU^t)_8, HCl$ , both  $^{31}P$  and  $^1H$  (of C-CH<sub>3</sub> protons) n.m.r. spectra show this phenomenon (8).

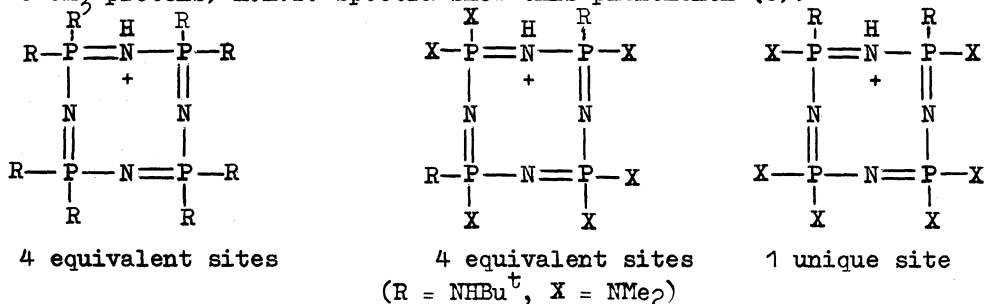



Non-equivalence was also demonstrated for (the four otherwise equivalent ring nitrogen atoms of) the 2,6-derivative,  $N_4P_4(NHBU^t)_2(NMe_2)_6, HCl$ , from its  $^1H$  n.m.r. spectrum. In the 2,4-isomer, even in the free base there are three non-equivalent sites in the ratio 1:1:2. Whilst in the former isomer, all ring nitrogen atoms have the same basicity, this is probably not the case in the latter and the protonation site shown may be the only one with a significant residence time.

Proton shifts have been reported for spirobi(cyclotriphosphazatrienes) (89) (all four non-spiro phosphorus atoms are equivalent in solution as shown by  $^{31}P$  n.m.r. spectroscopy).

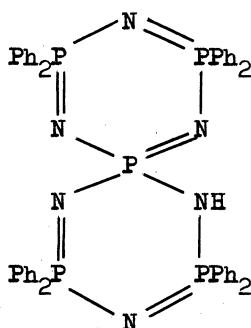

They have also been observed in some acyclic aminophosphazenes (90),



where they were initially demonstrated by means of infrared spectroscopy, viz., (91):

|  | $\nu_{C=O} \text{ cm}^{-1}$<br>conjugated | $\nu_{C=O} \text{ cm}^{-1}$<br>unconjugated |
|--|---|---|
|  | 1616                                      |   |
|  |   | 1710  |
|  | 1600                                      |   |
|  | 1609                                      | 1704  |
|  |   | 1710  |

The basicities of cyclic (1, 39) and acyclic (90) phosphazenes have been extensively studied and the data are now sufficiently precise to allow predictions of sites of protonation in most cases.

One is studying here the equilibria  $B' + H^+ \rightleftharpoons [B'H]^+$ , *i.e.*, the base is neutral, its conjugate acid positively charged. In tautomerism we deal with  $B + H^+ \rightleftharpoons [BH]^+$  where  $B = B' - H^+$  and thus our base, B, is negatively charged, whilst its conjugate acid is neutral.

Thus whilst the absolute values of substituent constants may differ somewhat for the bases B' and B, the relative order might well remain unchanged and thus allow some semi-quantitative predictions of tautomeric behaviour.

First of all, let me review hydroxycyclophosphazenes. The fully hydroxylated species,  $N_3P_3O_6H_6$  and  $N_4P_4O_8H_8$ , are without doubt entirely in the oxophosphazane forms (*cf.* ref. 40). A considerable number of monohydroxylated species are known, mainly of the trimer, *e.g.*,

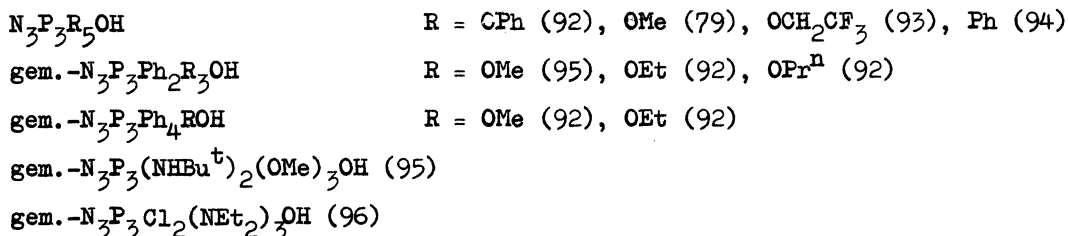

and at least one tetramer derivative,  $N_4P_4(OMe)_7OH$  (79).

Higher hydroxylated compounds have also been reported, *e.g.*,

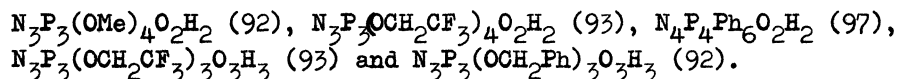

For all of the above, except  $N_3P_3Ph_5OH$  (94) and  $N_4P_4Ph_6O_2H_2$  (97) (which were described as hydroxyphosphazenes), the oxophosphazane structure was preferred.

Four possible tautomeric forms (C  $\rightarrow$  F) of the monohydroxy trimer are feasible [one OH(C), three NH (D  $\rightarrow$  F)], of which the two  $\alpha$ -tautomers (D) and (E) are equivalent, if the two non-hydroxylated phosphorus atoms are symmetrically substituted (R = R') ( $\alpha$  and  $\gamma$  indicate positions relative to P-OH or P=O group).

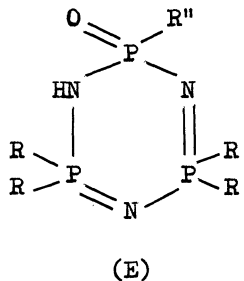
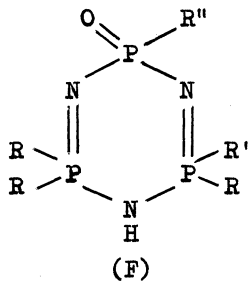
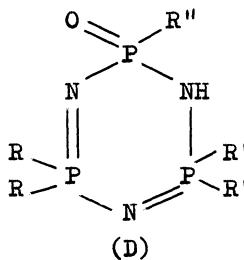
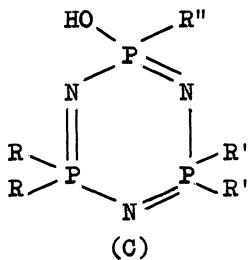

Hydrogen bonding is possible, indeed likely, in all four cases. For (C) one has the likely units

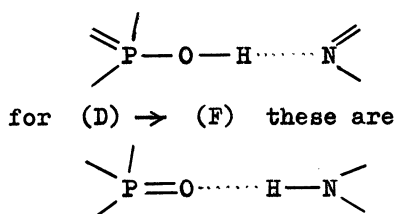

Obviously if the hydrogen bonds become particularly strong, as in the very short and symmetric hydrogen bonds in  $\text{O} \cdots \cdots \text{O}$  systems, the above ceases to have any meaning (98).

Tautomers (C  $\rightarrow$  E) could form (by interaction with the  $\alpha$ -ring nitrogen atoms) cyclic eight-membered ring dimers which, in inert solvents may well be concentration independent. By contrast, tautomer (F) would be forming concentration-dependant oligomeric species.

Only for  $\text{N}_3\text{P}_3\text{Ph}_5\text{OH}$  has tautomer (C) been postulated (94); for all others, structures based on N-H tautomers have been explicitly or implicitly assigned. Thus, e.g., for  $\text{N}_3\text{P}_3(\text{OPh})_5\text{OH}$ , gem.- $\text{N}_3\text{P}_3\text{Ph}_2(\text{OR})_3\text{OH}$ , gem.- $\text{N}_3\text{P}_3\text{Ph}_4(\text{OR})\text{OH}$ , infra-red evidence was cited in favour of  $\text{P}=\text{O}$  and  $\text{N}-\text{H}$  groupings (92).

Molecular weight determinations in solutions indicated dimer formation for gem.- $\text{N}_3\text{P}_3\text{Cl}_2(\text{NEt}_2)_3\text{OH}$  (96),  $\text{N}_3\text{P}_3(\text{OMe})_5\text{OH}$  (79),  $\text{N}_4\text{P}_4(\text{OMe})_7\text{OH}$  (79), gem.- $\text{N}_3\text{P}_3\text{Ph}_2(\text{OMe})_3\text{OH}$  (95) and gem.- $\text{N}_3\text{P}_3(\text{NHBu}^t)_2(\text{OMe})_3\text{OH}$  (95). Whilst perhaps these determinations might have been carried out over a greater range of concentrations and in a wider range of solvents, they nevertheless provide some reasonably firm evidence that the above five compounds are not in the tautomeric form (F).

General considerations of phosphorus chemistry make tautomer (C) less likely than (D), (E) or (F). Detailed n.m.r. investigations in solutions should be informative. One would expect different chemical shift values for  $\text{=P(O)R}$  than for  $\text{=P(OH)R}$ , which in turn might be similar to  $\text{=P(OR')R}$ . In addition, one would expect changes in phosphorus-phosphorus spin-spin coupling constants. Thus, a  $\text{P-NH-P}$  unit would be anticipated to show a lower  $^2J(\text{P-P})$  value than an otherwise analogous  $\text{P=N-P}$  moiety.  $^{31}\text{P}$  N.m.r. spectroscopy might thus be expected to give the following general results: tautomer (C) and (F) would give  $\text{AB}_2$  (or  $\text{AX}_2$ ) spectra provided both non-hydroxylated phosphorus atoms have the same substituents. Tautomer (D) and (E) would give  $\text{AB}_2$  (or  $\text{AX}_2$ ) spectra unless the two  $\alpha$ -nitrogen positions became non-equivalent either through (i) both non-hydroxylated phosphorus atoms having the same substituents but the proton exchange is slow, or (ii) the above two phosphorus atoms having different substituents, when spectra of type  $\text{ABC}$  (or  $\text{ABX}$  or  $\text{AMX}$ ) would arise. If two or more tautomers were present under conditions of slow exchange, two or more of the above spectra would be observed, probably superimposed.

Let us return to basicity measurements and see if we can predict anything from the experience gained there. As mentioned above, we are dealing with the system

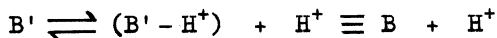

Provided we need to differentiate only between tautomers (D) and (E), we need to make no assumptions regarding the electron releasing properties of

the  $\begin{array}{c} \diagup \\ \text{P} \\ \diagdown \end{array} \begin{array}{c} \text{O}^- \\ \text{R} \end{array}$  moiety relative to  $\begin{array}{c} \diagup \\ \text{P} \\ \diagdown \end{array} \begin{array}{c} \text{Cl} \\ \text{R} \end{array}$ . (The P-Cl bond is the standard

for basicity measurements in cyclophosphazene chemistry. No assumptions are made regarding various possible resonance contributions to  $\text{=PRO}^-$ ). If we wish to include tautomer (F) in our discussions, however, we need to assess the contribution of  $\text{P-O}^-$  relative to  $\text{P-Cl}$  to the basicity of the molecule.

In organic chemistry U.V. spectroscopy shows an electron-release (in the perturbed state) to the phenyl ring (99):

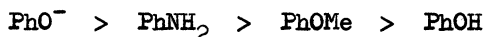

A similar order is observed in electrophilic aromatic substitution (100).

In phosphorus chemistry we obtain similar information from P-O bond lengths in a series of related compounds about electron back-donation in the ground state.

| <u>Compound</u>   | <u>P-O bond length (Å)</u> |
|---|----------------------------|
| $\text{Ph}_3\overset{+}{\text{P}}\text{-O}^-$                 | 1.46(1) (101)              |
| $\text{Ph}_2\overset{+}{\text{MeP}}\text{-OCH}_2\text{CMe}_3$ | 1.568(4) (66)              |
| $\text{Ph}_3\overset{+}{\text{P}}\text{-OH}$                  | 1.64(1) (102)              |

The trend for unsaturated phosphorus is similar to that for unsaturated carbon indicating electron-release in the ground state:

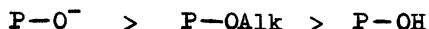

This is likely to be retained, or even enhanced, in the perturbed state (e.g., on protonation).

I have examined elsewhere (1) likely causes for the exceptionally high basicity contribution of the triphenylphosphazanyl group,  $\text{Ph}_3\text{P}=\text{N}$ , for which  $\alpha_{\text{R}} = 10.3$ . It probably arises from a combination of (i) number of lone pairs (two) of electrons available for back donation, and (ii) a low coordination number (two) of nitrogen, which allows it plenty of scope to take up a favourable conformation for this electron-transfer.

An  $\text{-O}^-$  substituent, although more electronegative than nitrogen, has three lone pairs of electrons available and a coordination number of one. Hence, a bona fide case can be made for strong electron-release by this group. A selection of relevant substituent constants  $\alpha_{\text{R}}$  and  $\gamma_{\text{R}}$  are given below (1, 2, 103).

| R              | $\alpha_{\text{R}}$ | $\gamma_{\text{R}}$ |
|----------------|---------------------|---------------------|
| $\text{NH}_2$  | 6.0                 | 2.7                 |
| $\text{NHMe}$  | 5.8                 | 3.1                 |
| $\text{NHEt}$  | 5.8                 | 3.6                 |
| $\text{NMe}_2$ | 5.6                 | 2.8                 |
| $\text{OMe}$   | 3.6                 | 1.8                 |
| $\text{OEt}$   | 3.9                 | 1.9 <sub>5</sub>    |
| $\text{OPr}^i$ | 4.2                 | 2.1                 |

Hence, it seems not unreasonable to give  $\text{-O}^-$  at least as high a substituent constant as that of an amino group, say,  $\alpha_{\text{R}} = 6.0$ . As in general  $\alpha_{\text{R}} \approx 2\gamma_{\text{R}}$ , I assume  $\gamma_{\text{R}} = 3.0$ .

Using the established substituent constants for cyclotriphosphazatrienes and the earlier calculated value of -20.4 for  $\text{N}_3\text{P}_2\text{Cl}_6$  (104), we can now calculate the relative basicities of the three  $\text{N}_3\text{P}_3\text{R}_3\text{O}^-$  precursor conjugate bases of the tautomers (D  $\rightarrow$  F but not C) of  $\text{N}_3\text{P}_3\text{R}_3\text{O}^-$ . Tautomer (C), as I have discussed earlier is less probable than  $\text{N}_3\text{P}_3\text{R}_3\text{O}^-$  tautomers (D  $\rightarrow$  F). If all substituents (R, R', R'') are the same, tautomers (D) and (E) are equivalent. I will first examine R =  $\text{NMe}_2$ , i.e.,  $\text{N}_3\text{P}_3(\text{NMe}_2)_5\text{OH}$ .

|                               | Tautomer (D)<br>(precursor base) | Tautomer (F)<br>(precursor base) |
|-------------------------------|----------------------------------|----------------------------------|
| $\alpha_{O^-}$                | 6.0                              |                                  |
| $\gamma_{O^-}$                |                                  | 3.0                              |
| $\alpha_{NMe_2}$              | 16.8                             | 22.4                             |
| $\gamma_{NMe_2}$              | 5.6                              | 2.8                              |
| Statistical effect (105)      | 0.3                              |                                  |
| $pK'_a$ of $N_2P_3Cl_6$ (104) | -20.4                            | -20.4                            |
|                               | <u>8.3</u>                       | <u>7.8</u>                       |

Hence,  $\alpha$ -nitrogen protonation is preferred and the formation of tautomer (D) (or E) is likely.

If we decrease the values of  $\alpha_P$  and  $\gamma_P$  from 6.0 and 3.0 to say, 5.0 and 2.5 respectively, the calculated values for (D) and (F) would both be 7.3, *i.e.*, for these smaller values (for the substituent  $O^-$ ) both  $\alpha$ - and  $\gamma$ -tautomers would be present.

If we carry out similar calculations for a number of other homogeneously substituted derivatives,  $N_2P_3R_5O^-$ , we can see at which assumed values of  $\alpha_R$  (and  $\gamma_R$ ) both  $\alpha$ - and  $\gamma$ -tautomers would be present in approximately equal proportions.

| R                                | $\alpha_{O^-}$ | $\gamma_{O^-}$ |
|----------------------------------|----------------|----------------|
| NMe <sub>2</sub>                 | 5.0            | 2.5            |
| NHET                             | 4.0            | 2.0            |
| Ph                               | 3.0            | 1.5            |
| OMe                              | 3.0            | 1.5            |
| OPh                              | 3.0            | 1.5            |
| OCH <sub>2</sub> CF <sub>3</sub> | 1.0            | 0.5            |

In other words, in the more basic compounds a relatively small decrease in the substituent constants assumed would favour the  $\gamma$ -tautomer (F); for the less basic compounds a more drastic reduction would be needed.

Obviously any deviation of the actual values from the assumed  $\alpha_{O^-} = 2\gamma_{O^-}$  ratio would also shift the equilibrium predicted.

Thus, these calculations (using  $\alpha_{O^-} = 6.0$ ,  $\gamma_{O^-} = 3.0$ ) suggest that tautomer (D) [= (E)] ( $R = R' = R'' = OMe$ ) is the preferred form for  $N_2P_3(OMe)_5OH$ , which is also indicated experimentally by its dimer formation in benzene. It is the form postulated by the Roumanian workers (79). At room temperature its  $^{31}P$  spectrum is of the AB<sub>2</sub> type (95).

For  $N_2HP_3(O)Cl_2(NEt_2)_3$  (96) the situation is more complicated, as (D) and (E) are no longer equivalent. Calculations as above yield values for protonation sites (D), (E) and (F), of 2.1, -2.7 and -3.3 respectively. Basicity calculations obviously point to tautomer (D). Crystallographic investigations confirm this for the solid state (96). It is a dimer in benzene, its  $^{31}P$  spectrum is of the ABX type (shown in the Figure) whose interpretation is compatible with the calculations and the crystal structure.

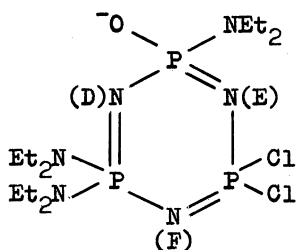

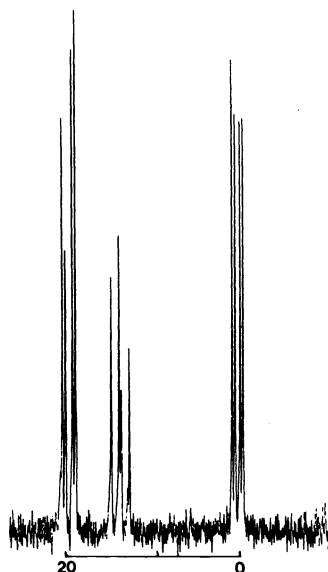
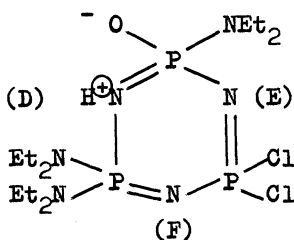

Figure. The  $^{31}\text{P}$   $\{^1\text{H}\}$  n.m.r. spectrum of  $\text{N}_3\text{HP}_3(\text{O})\text{Cl}_2(\text{NEt}_2)_3$  at 36.43 MHz.

The basicity of  $\text{N}_3\text{HP}_3(\text{O})\text{Cl}_2(\text{NEt}_2)_3$  has been measured earlier in nitrobenzene. A value of  $-2.7$  was found (106).<sup>3</sup> Provided  $\alpha_{\text{P}}$  and  $\gamma_{\text{P}}$  values are not (or not much) changed in the cyclotriphosphazadiene from those derived for cyclotriphosphazatrienes, sites (E) and (F) in the phosphazadiene,  $\text{N}_3\text{HP}_3(\text{O})\text{Cl}_2(\text{NEt}_2)_3$



should have basicities in nitrobenzene of  $-2.7$  and  $-3.3$  respectively, lowered of course by the effect of protonation at site (D). As mentioned above,  $-2.7$  was observed experimentally. Provided the above assumptions are all correct, this would imply either that the effect of protonation at site (D) was negligible (less likely) or that the values assumed for  $\alpha_{\text{O}^-}$  and  $\gamma_{\text{O}^-}$  are too low (more likely). In any case, it indicates that the phosphazadiene is probably protonated at site (E) and that the electron-releasing power

of the  $-\text{O}^-$  substituent is substantial. Finally, two further examples: gem- $\text{N}_3\text{P}_3\text{Ph}_2(\text{OMe})_3\text{OH}$ . Calculations suggest that both  $\alpha$ -tautomers (D and E) might be present. It forms a dimer in solution in benzene (95) and its  $^{31}\text{P}$  spectrum at  $-40^\circ\text{C}$  (95) shows the presence of two species. An X-ray crystallographic investigation (107) of a crystalline sample indicates a dimeric structure based on the tautomer (D,  $\text{R}' = \text{Ph}$ ,  $\text{R} = \text{R}'' = \text{OMe}$ ) shown. Basicity calculations indicate its precursor base to be marginally more basic than that of tautomer (E).

For gem- $\text{N}_3\text{P}_3(\text{NHBu}^t)_4(\text{OMe})\text{OH}$ , calculations suggest the possibility of the  $\gamma$ -tautomer (F) being of the same order of basicity as the  $\alpha$ -tautomers (D and E).

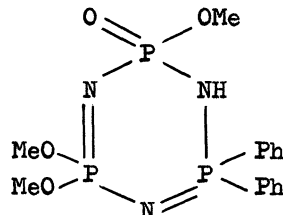

It must be stressed that small changes in basicity will cause large changes in the tautomer population and whilst basicity substituent constant calculations often provide a reliable guide for the determination of structure of positional isomers (1, 39), they are probably as yet not sufficiently precise to predict accurately tautomer equilibria, especially when the calculated values (for different sites) are very close. It is hoped however that in many cases they will be able to predict accurately the structure of the major phosphazene tautomer (or tautomers) present.

## CONCLUSIONS

I have tried to show some recent, and to me exciting, developments in phosphorus-nitrogen chemistry. In particular, I have endeavoured to

demonstrate the fruitful interactions between hypothesis and experiment, between synthesis, reactivity, and structure. I hope I have succeeded.

## REFERENCES

1. R. A. Shaw, Z. Naturforsch., 31b, 641 (1976).
2. R. N. Das, R. A. Shaw, B. C. Smith and M. Woods, J.C.S. Dalton, 709 (1973).
3. S. K. Das, R. Keat, R. A. Shaw and B. C. Smith, J. Chem. Soc. (A), 1677 (1966).
4. D. J. Lingley, R. A. Shaw, M. Woods and S. S. Krishnamurthy, Phosphorus and Sulfur, 4, 379 (1978).
5. S. K. Das, R. Keat, R. A. Shaw and B. C. Smith, J. Chem. Soc., 5032 (1965).
6. R. Keat and R. A. Shaw, Angew. Chem. Internat. Ed., 7, 212 (1968).
7. S. S. Krishnamurthy, A. C. Sau, A. R. Vasudeva Murthy, R. Keat, R. A. Shaw and M. Woods, J.C.S. Dalton, 1405 (1976).
8. S. S. Krishnamurthy, A. C. Sau, A. R. Vasudeva Murthy, R. Keat, R. A. Shaw and M. Woods, J.C.S. Dalton, 1980 (1977).
9. G. Bulloch and R. Keat, Inorg. Chim. Acta, 33, 245 (1979).
10. R. Jefferson, J. F. Nixon, T. M. Painter, R. Keat and L. Stobbs, J.C.S. Dalton, 1415 (1973).
11. G. Bulloch and R. Keat, J.C.S. Dalton, 2010 (1974).
12. D. Millington and D. B. Sowerby, J.C.S. Dalton, 2035 (1972).
13. S. S. Krishnamurthy, M. N. Sudheendra Rao, R. A. Shaw, A. R. Vasudeva Murthy and M. Woods, Inorg. Chem., 17, 1527 (1978).
14. R. Keat, J.C.S. Dalton, 876 (1974).
15. I. Irvine and R. Keat, J.C.S. Dalton, 17 (1972).
16. G. Bulloch, R. Keat and N. H. Tennent, J.C.S. Dalton, 2329 (1974).
17. R. Keat, Phosphorus, 1, 253 (1972); J.C.S. Dalton, 876 (1974).
18. D. Dell, B. W. Fitzsimmons and R. A. Shaw, J. Chem. Soc., 4070 (1965).
19. D. Dell, B. W. Fitzsimmons, R. Keat and R. A. Shaw, J. Chem. Soc. (A), 1680 (1966).
20. J. L. Schmutz and H. R. Allcock, Inorg. Chem., 14, 2433 (1975).
21. A. P. Carroll and R. A. Shaw, J. Chem. Soc. (A), 914 (1966).
22. B. Thomas and G. Grossmann, Z. anorg. allg. Chem., 448, 100 (1979).
23. E. Niecke, O. Glemser and H. W. Roesky, Z. Naturforsch., 24b, 1187 (1969).
24. A. P. Carroll, R. A. Shaw and M. Woods, J.C.S. Dalton, 2736 (1973).
25. H. Bode, K. Bütow and G. Lienau, Chem. Ber., 81, 547 (1948).
26. H. R. Allcock and R. L. Kugel, Inorg. Chem., 5, 1016 (1966).
27. M. Becke-Goehring and B. Boppel, Z. anorg. allg. Chem., 322, 239 (1963).

28. S. S. Krishnamurthy, K. Ramachandran, A. R. Vasudeva Murthy, R. A. Shaw and M. Woods, Inorg. Nuclear Chem. Letters, 13, 407 (1977).
29. R. A. Shaw and M. Woods, unpublished results.
30. Y. S. Babu, H. Manohar, K. Ramachandran, and S. S. Krishnamurthy, Z. Naturforsch., 33b, 588 (1978).
31. T. Chivers and R. Hedgeland, Canad. J. Chem., 50, 1017 (1972).
32. H. R. Allcock and R. L. Kugel, J. Amer. Chem. Soc., 91, 5452 (1969).
33. H. Manns and H. Specker, Z. anorg. allg. Chem., 425, 127 (1976); H. Rose and H. Specker, Z. anorg. allg. Chem., 426, 275 (1976); V. N. Sharov, V. N. Prons, V. V. Korolko, A. L. Klebanskii and G. P. Kondratenkov, Zh. Obshch. Khim., 45, 1953 (1975).
34. H. R. Allcock, J. Amer. Chem. Soc., 85, 4050 (1963); 86, 2591 (1964).
35. F. H. Westheimer, Accounts Chem. Res., 1, 70 (1968).
36. H. R. Allcock, R. L. Kugel and G. Y. Moore, Inorg. Chem., 14, 2831 (1975).
37. R. Keat, R. A. Shaw and M. Woods, J.C.S. Dalton, 1582 (1976).
38. S. S. Krishnamurthy, K. Ramachandran, A. R. Vasudeva Murthy, R. A. Shaw, and M. Woods, J.C.S. Dalton, in the press.
39. R. A. Shaw, Pure and Appl. Chem., 44, 317 (1975).
40. R. A. Shaw, Phosphorus and Sulfur, 4, 101 (1978).
41. R. A. Shaw, Phosphorus and Sulfur, 5, 363 (1979).
42. Y. S. Babu, T. S. Cameron, S. S. Krishnamurthy, H. Manohar and R. A. Shaw, Z. Naturforsch., 31b, 999 (1976).
43. K. W. Muir and J. F. Nixon, Chem. Commun., 1405 (1971); K. W. Muir, J.C.S. Dalton, 259 (1975).
44. R. Keat and D. G. Thompson, Angew. Chem. Internat. Ed., 16, 797 (1977).
45. R. Keat, D. S. Rycroft and D. G. Thompson, J.C.S. Dalton, 1224 (1979).
46. G. Bulloch and R. Keat, J.C.S. Dalton, 2010 (1974).
47. V. P. Kukhar', J. Gen. Chem. U.S.S.R., 40, 761 (1970).
48. C. D. Flint, E. H. M. Ibrahim, R. A. Shaw, B. C. Smith and C. P. Thakur, J. Chem. Soc. (A), 3513 (1971); E. H. M. Ibrahim, R. A. Shaw, B. C. Smith, C. P. Thakur, M. Woods, G. J. Bullen, J. S. Rutherford, P. A. Tucker, T. S. Cameron, K. D. Howlett and C. K. Prout, Phosphorus, 1, 153 (1971).
49. J. D. Healy, R. A. Shaw and M. Woods, Phosphorus and Sulfur, 5, 239 (1978).
50. J. Weiss and G. Hartmann, Z. anorg. allg. Chem., 351, 152 (1967).
51. S. S. Krishnamurthy, A. C. Sau, A. R. Vasudeva Murthy, R. A. Shaw, M. Woods and R. Keat, J. Chem. Res., (S) 70; (M) 0860-0884 (1977).
52. T. S. Cameron, Kh. Mannan, S. S. Krishnamurthy, A. C. Sau, A. R. Vasudeva Murthy, R. A. Shaw and M. Woods, J.C.S. Chem. Commun., 975 (1975).
53. T. S. Cameron and Kh. Mannan, Acta Cryst., B33, 1367 (1977).
54. S. S. Krishnamurthy, K. Ramachandran, A. C. Sau, R. A. Shaw,



- A. R. Vasudeva Murthy and M. Woods, Inorg. Chem., **18**, 2010 (1979).
55. S. S. Krishnamurthy, K. Ramachandran and M. Woods, J. Chem. Res. (S) 92; (M) 1258-1266 (1979).
56. T. S. Cameron, R. E. Cordes and F. A. Jackman, Acta Cryst., **B35**, 980 (1979).
57. T. S. Cameron, personal communication.
58. P. M. Sundaram, S. S. Krishnamurthy, A. R. Vasudeva Murthy, R. A. Shaw and M. Woods, IUPAC Symposium on Phosphorus Chemistry, Halle (1979).
59. J. D. Healy, R. A. Shaw, B. C. Smith, C. P. Thakur and M. Woods, J.C.S. Dalton, 1286 (1974).
60. S. S. Krishnamurthy, M. N. Sudheendra Rao, A. R. Vasudeva Murthy, R. A. Shaw and M. Woods, Ind. J. Chem. (A), **14**, 823 (1976).
61. C. Y. Cheng and R. A. Shaw, J.C.S. Perk. I, 1739 (1976).
62. M. Hasan, R. A. Shaw and M. Woods, J.C.S. Dalton, 2202 (1975).
63. A. Gieren, B. Dederer, H. W. Roesky and E. Janssen, Angew. Chem. Internat. Ed., **15**, 783 (1976).
64. e.g., R. G. Harvey and E. R. de Sombre, Topics in Phosphorus Chemistry, (Editors: M. Grayson and E. J. Griffith), Interscience Publishers, New York, London, Sidney, **1**, 57 (1964).
65. B. W. Fitzsimmons and R. A. Shaw, Proc. Chem. Soc., 258 (1961); B. W. Fitzsimmons, C. Hewlett, and R. A. Shaw, J. Chem. Soc., 4459 (1964); B. W. Fitzsimmons, C. Hewlett and R. A. Shaw, J. Chem. Soc., 7432 (1965).
66. K. Henrick, H. R. Hudson and A. T. C. Kow, personal communication.
67. K. S. Dhathathreyan, S. S. Krishnamurthy, A. R. Vasudeva Murthy, R. A. Shaw and M. Woods, Inorg. Nuclear Chem. Letters, **15**, 109 (1979).
68. R. A. Shaw and E. T. Mukmenev, Dokl. Akad. Nauk SSSR, **208**, 379 (1973).
69. V. I. Schevtschenko, V. P. Tkatsch and A. V. Kirsanov, Zh. obshch. Khim., **35**, 1224 (1965).
70. A. N. Pudovik, I. M. Aladzheva and V. G. Kotova, Zh. obshch. Khim., **37**, 1173 (1967).
71. M. I. Kabatschnik and V. A. Giljarov, Izvest. Akad. Nauk SSSR, Otd. Khim. Nauk, 819 (1961).
72. P. S. Pischtschimuka, Zh. obshch. Khim., **44**, 1406 (1912).
73. M. I. Kabatschnik, V. A. Giljarov and Chang Cheng-De, Izvest. Akad. Nauk SSSR, Ser. Khim., 665 (1965).
74. I. M. Filatova, E. L. Saizeva, A. P. Simonov and A. J. Jakubovitsch, Zh. obshch. Khim., **36**, 1861 (1966); **38**, 1304 (1968).
75. L. Riesel, A. Claussnitzer and C. Ruby, Z. anorg. allg. Chem., **433**, 200 (1977).
76. M. I. Kabatschnik, N. N. Zaslavskaja, V. A. Giljarov, P. V. Petrovskij, and V. A. Svoren, Dokl. Akad. Nauk SSSR, **228**, 849 (1976).
77. J. F. Klebe, Accounts Chem. Res., **3**, 299 (1970).

78. G. Czieslik, G. Flaskerud, R. Höfer and O. Glemser, Chem. Ber., 106, 399 (1973).
79. R. Vîlceanu and P. Schulz, Phosphorus, 6, 231 (1976).
80. B. E. Cooper, Chem. and Ind. (London), 794 (1978).
81. J. Pump and E. G. Rochow, Chem. Ber., 97, 627 (1964).
- 81a. M. Meyer zur Heyde, Tetrahedron Lett., 1425 (1969).
82. J. C. Wilburn, P. Wisian-Neilson and R. H. Neilson, Inorg. Chem., 18, 1429 (1979).
83. D. E. C. Corbridge, The Structural Chemistry of Phosphorus, Elsevier Scientific Publishing Company, Amsterdam, London, New York, 203, 246 (1974).
84. A. Schmidpeter and H. Rossknecht, Angew. Chem. Internat. Ed., 8, 614 (1969); Z. Naturforsch., 26b, 81 (1971).
85. A. Schmidpeter, J. Ebeling, H. Stary and C. Weingand, Z. anorg. allg. Chem., 394, 171 (1972).
86. D. Houalla, T. Mouheich, M. Sanchez and R. Wolf, Phosphorus, 5, 229 (1975).
87. R. Burgada, Phosphorus and Sulfur, 2, 237 (1976).
88. A. Munoz, B. Garrigues and R. Wolf, Phosphorus and Sulfur, 4, 47 (1978).
89. A. Schmidpeter and H. Eiletz, Phosphorus, 6, 113 (1976).
90. M. I. Kabatschnik, Phosphorus, 1, 117 (1971).
91. M. I. Kabatschnik, V. A. Giljarov and E. M. Popov, Zh. obshch. Khim., 32, 1598 (1962).
92. B. W. Fitzsimmons, C. Hewlett, K. Hills and R. A. Shaw, J. Chem. Soc. (A), 679 (1967).
93. H. R. Allcock and E. J. Walsh, J. Amer. Chem. Soc., 94, 119 (1972).
94. C. D. Schmulbach and V. R. Miller, Inorg. Chem., 7, 1621 (1966).
95. K. S. Dhathathreyan, S. S. Krishnamurthy, R. A. Shaw, A. R. Vasudeva Murthy and M. Woods, unpublished results.
96. G. J. Bullen, P. E. Dann, M. L. Evans, M. B. Hursthouse, R. A. Shaw, K. Wait, M. Woods and H. S. Yu, Z. Naturforsch., 31b, 995 (1976).
97. D. L. Herring and C. M. Douglas, Inorg. Chem., 4, 1012 (1965).
98. I. Olovsson and P.-G. Jönsson, The Hydrogen Bond, (Editors: P. Schuster, G. Zundel and C. Sandorfy), North-Holland, Amsterdam, New York, Oxford, 393 (1976).
99. J. P. Phillips, Spectra-Structure Correlation, Academic Press, New York and London, 52 (1964).
100. C. K. Ingold, Structure and Mechanism in Organic Chemistry, G. Bell and Sons, Ltd., London, 242, 303 (1953).
101. G. Bandoli, G. Bartolozzo, D. A. Clemente, U. Croatto and C. Panattoni, J. Chem. Soc. (A), 2778 (1970).
102. T. S. Cameron and C. K. Prout, J. Chem. Soc. (C), 2289 (1969).
103. D. Feakins, W. A. Last, N. Neemuchwala and R. A. Shaw, J. Chem. Soc., 2804 (1965).

104. R. A. Shaw, Endeavour, 74 (1968).
105. D. Feakins, W. A. Last, S. N. Nabi, R. A. Shaw and P. Watson, J. Chem. Soc. (A), 196 (1969).
106. S. N. Nabi and R. A. Shaw, unpublished results.
107. T. S. Cameron and C. Chan, personal communication.