

Asymmetric synthesis with boronic esters

Donald S. Matteson, Kizhakethil Mathew Sadhu, Rahul Ray, Mark L. Peterson, Debesh Majumdar, Gerald D. Hurst, P.K. Jesthi, D.J.S. Tsai, and E. Erdik

Department of Chemistry, Washington State University, Pullman, WA 99164, U.S.A.

Abstract - Reaction of (dichloromethyl)lithium with (+)-pinanediol alkylboronates at -100°C followed by treatment with anhydrous zinc chloride and warming to $0-25^{\circ}\text{C}$ results in insertion of a chloromethyl group into the carbon-boron bond to increase the chain length by one carbon and form (1S)-1-chloroalkylboronic esters in 85-99% yields and usually 99% or better diastereoselectivities. With (+)-pinanediol methylboronate the diastereoselectivity falls to 95%. The chloride can be replaced by Grignard reagents to form *sec*-alkylboronic esters, or by lithium benzyloxide to form 1-benzyloxyboronic esters. A second chiral center can be introduced by another reaction with (dichloromethyl)lithium, and in principle there is no limit to the number of adjacent chiral centers that could be assembled in this manner. The process tolerates other functional groups as long as they are inert toward carbanions. It is possible to use (-)-pinanediol to obtain the corresponding (1R)-1-chloroboronic esters. The utility of this approach to chiral synthesis has been demonstrated with simple insect pheromones containing two chiral centers. Another useful chiral directing group is (R,R)-2,3-butanediol, which yields 95-96% diastereoselectivities, even in the formation of the 1-chloroethylboronic ester. An advantage of this directing group is that it yields the same results via reaction of (R,R)-2,3-butanediol dichloromethylboronate with Grignard or lithium reagents, because the C_2 symmetry of the chiral group leads to the same borate complex intermediate regardless of the order of attachment of the dichloromethyl and alkyl groups. A second advantage is that the butanediol 1-chloroalkylboronic esters hydrolyze readily on contact with water, and the resulting (1S)-1-chloroalkylboronic acids are usually crystalline solids which can be enantiomerically purified by recrystallization, and which could easily be esterified with a chiral group which directs the next 1-chloroboronic ester to be the (1R)-isomer.

INTRODUCTION

The ideal asymmetric synthesis would include the following features: (1) high chiral selectivity; (2) high chemical yields; (3) independently selectable configuration for each chiral center; (4) an unlimited number of chiral centers; (5) compatibility with a variety of functional groups; (6) applicability to a wide range of synthetic problems; (7) readily available starting materials; (8) simple, reproducible, and safe laboratory procedures; (9) recyclable chiral directing groups; (10) low cost. "Deviations from ideality" are the norm, and even enzymatic syntheses are "nonideal" because of their applicability to only a very limited range of possible structures. The boronic ester chemistry being developed in our laboratory shows favorable characteristics with respect to all ten of the listed features, and may provide the most general approach to chiral synthesis yet devised.

A brief history of 1-haloalkylboronic esters

The first 1-haloalkylboronic esters were synthesized by the author twenty-five years ago (ref. 1) and it was soon shown that the boron greatly activates the neighboring halogen toward nucleophilic displacement (ref. 2). The reaction of 1-haloalkylboronic esters with Grignard reagents was shown to proceed by way of tetracoordinate borate complexes which are stable at low temperatures but rearrange near room temperature (ref. 2). Although it was obvious from the beginning that this chemistry provided an efficient new method of carbon-carbon bond formation, methods of making 1-haloalkylboronic esters lacked generality and convenience, and synthetic applications were confined to the preparation of various exotic boron compounds (ref. 3). Wider synthetic applicability was implicit in the discovery by Brown, Yamamoto, and coworkers that *sec*-alkylboronic esters could be brominated and that highly branched carbon skeletons could be formed by the reactions of the resulting

haloalkylboronic esters with Grignard or lithium reagents (ref. 4). However, a truly efficient and general synthesis of 1-haloalkylboronic esters was needed before their full synthetic potential could be realized. The key reagent has turned out to be (dichloromethyl)lithium.

(Dichloromethyl)lithium was first prepared (ref. 5) and shown to insert a chloromethyl group into carbon-boron bonds (ref. 6) by Kóbrich and coworkers. Rathke, Chao, and Wu used the reagent to prepare (dichloromethyl)boronic acid and its esters, and showed that the latter would react with alkylolithium reagents to form the homologous 1-chloroalkylboronic esters, which were not isolated but oxidized to aldehydes, not always in high yields (ref. 7). The synthetic potential of the reaction of (dichloromethyl)lithium with boronic esters to form the homologous 1-chloroalkylboronic esters was first realized by Matteson and Majumdar, who showed that the reaction was a highly efficient process that could be used to prepare a considerable variety of structures (ref. 8). Functional groups tolerated included a remote ethylene ketal, a 1-benzyloxy group in the starting boronic ester (which becomes a 2-benzyloxy substituent in the product), and a carboxylic ester group where at least two additional carbon atoms intervened between it and the boronic ester group.

PINANEDIOL BORONIC ESTERS

a. Preparation

It was readily apparent that chiral control of the new 1-chloroalkylboronic synthesis would be of major significance. After a modest asymmetric induction was observed in the conversion of diacetone mannitol benzylboronate to the 1-chloro-2-phenylethylboronate, a more powerful chiral directing group was sought. Noting that alpha-pinene derivatives had provided Brown and Zweifel with the key to a highly enantioselective secondary alcohol synthesis by hydroboration (ref. 9), Ray and Matteson investigated the osmium tetroxide catalyzed oxidation of alpha-pinene to produce pinanediol (ref. 10). Several approaches failed, but excellent results were obtained by modifying the amine oxide method (ref. 11) to utilize trimethylamine oxide in the presence of pyridine (ref. 10). More recently, we have routinely added small amounts of triethylamine to insure against over-oxidation. The diol derived from (+)-alpha-pinene has a (+)-rotation in toluene and a (-)-rotation in methanol and will be designated as (s)-pinanediol (1) because it directs the formation of (1S)-1-chloroalkylboronic esters. (r)-Pinanediol (2) is also easily prepared. The pinenes are either enantiomerically impure or expensive, but salts of pinanediol borate complexes can be recrystallized to high enantiomeric purity (ref. 12). (s)-Pinanediol is now a commercially available laboratory reagent (ref. 13).

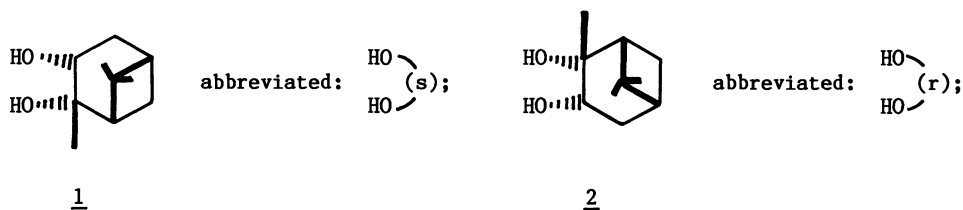

Boronic esters of pinanediol form readily on contact of a boronic acid or ester with pinanediol or pinanediol hydroxyboronate in an ether or hydrocarbon solvent. Pinanediol boronates are thermodynamically stable toward hydrolysis, so much so that a solution of pinanediol in hexane will dissolve boric acid and liberate water. This stability is a convenience for purposes of chromatography and other purification procedures, but can be an obstacle when cleavage of the pinanediol group is needed in a synthesis.

b. Synthesis of (2S, 3S)- and (2R, 3S)-3-phenyl-2-butanol

Reaction of (s)-pinanediol alkylboronates (3) with (dichloromethyl)lithium at -100°C results in formation of borate complexes (4) which rearrange at $0-25^{\circ}\text{C}$ to form (s)-pinanediol (1S)-1-chloroalkylboronates (5) with high diastereoselectivity (ref. 11). For proof of stereochemistry, the chloroalkylboronic esters (5) were treated with Grignard or lithium reagents to form borate complexes (6) as previously described (ref. 2), which rearranged on warming to form sec-alkylboronic esters (7), which were oxidized with alkaline sodium perborate (or hydrogen peroxide) to secondary alcohols (8) of known optical rotation and absolute configuration. Diastereoselectivities were generally improved to 99% or better by the use of zinc chloride catalysis in the rearrangement of 4 (ref. 14), to be discussed in subsection c.

The initial attempt at reaction of (s)-pinanediol phenylboronate (3, R = Ph) with (dichloromethyl)lithium resulted in very slight diastereoselection in the opposite direction from usual. It was soon realized that the reactive (s)-pinanediol 1-chlorobenzylboronate (9) might epimerize as a result of exchange with chloride ion liberated in the process of

its formation. When the rearrangement of the intermediate borate complex (4, R = Ph) was carried out at 0 °C for one hour, the resulting 9 was found to be 97–98% diastereomerically pure (ref. 12).

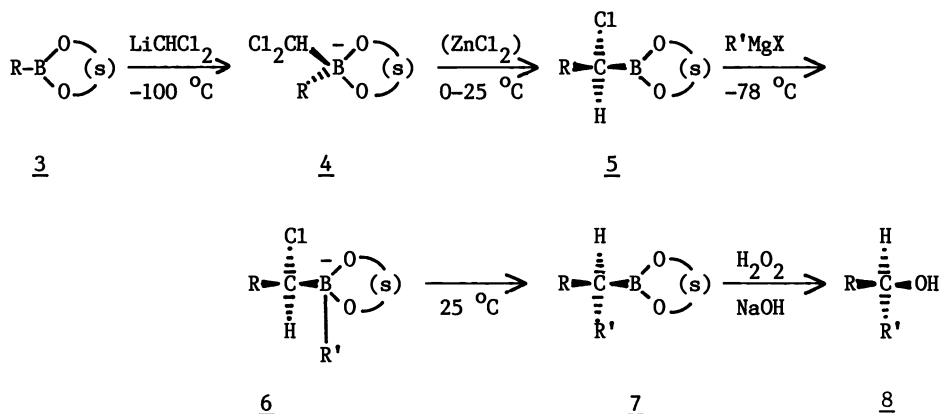

The potential synthetic utility of the new process was demonstrated by treatment of 9 with methylmagnesium bromide to form the (1*S*)-1-phenylethylboronic ester (10). A second chiral center was then installed by repetition of the reaction sequence as illustrated in Scheme 2, and the synthesis was completed by the usual peroxidic oxidation of the boronic ester to form (2*S*,3*S*)-3-phenyl-2-butanol (11), which had previously been thoroughly characterized by Cram for his classical studies of nonclassical ions (ref. 15).

Installation of the second chiral center with the opposite absolute configuration was accomplished by cleaving the (s)-pinanediol from 10 and replacing it by (r)-pinanediol. Unfortunately, attempts to achieve simple ligand exchange on boron failed, and destruction of the pinanediol group with boron trichloride had to be used. Esterification of the purified (1*S*)-1-phenylethylboronic acid (12) with (r)-pinanediol to form 13 followed by the usual construction of the second chiral center led ultimately to (2*R*,3*S*)-3-phenyl-2-butanol (14).

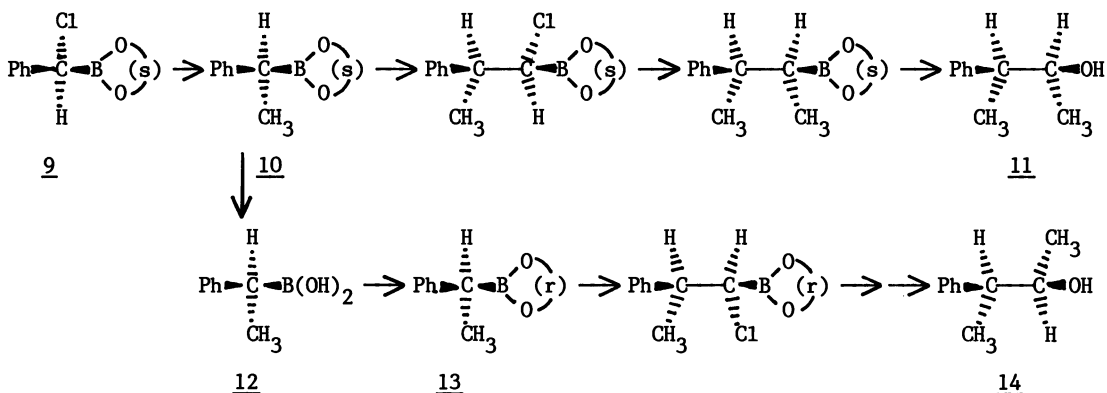

c. Zinc chloride catalysis

The syntheses of 11 and 14, subsection b, were highly efficient, but only when all of the migrating groups were aryl or benzylic. Attempts to apply similar chemistry to unactivated pinanediol alkylboronates were only moderately successful. For example, reactions of (s)-pinanediol butylboronate with (dichloromethyl)lithium yielded 61% of 90% diastereomerically pure (s)-pinanediol 1-chloropentylboronate, and with (s)-pinanediol methylboronate the diastereoselectivity fell to 75% (ref. 12). The yield fell to 30% with (s)-pinanediol isobutylboronate (ref. 16), and the reaction failed altogether with the benzyloxymethylboronate (ref. 12).

The possibility of improving the reaction with the aid of a catalyst was investigated. After mercuric chloride was found to retard the epimerization process (see subsection e) (ref. 17), several metal salts which complex chloride ion were tested. Outstanding results

were obtained with zinc chloride, with the optimum proportion of catalyst being slightly less than one mole. (s)-Pinanediol isobutylboronate (**3**, R = *i*-Bu) was converted to (s)-pinanediol (1S)-1-chloro-3-methylbutylboronate (**5**, R = *i*-Bu) in 90% yield and 99.5% diastereoselectivity (ref. 14). The diastereoselectivity was estimated from the proton NMR spectrum of an acetamido derivative (see subsection f), which showed a large separation between the NH peaks of the (1R)- and (1S)-epimers. It was subsequently found that the NMR spectra of many pinanediol 1-chloroalkylboronates show differences in the 200 MHz NMR spectra sufficient for analytical purposes, most often in one of the pinanyl protons which appears as a doublet near 1.1 ppm.

The 90% yield with 99.5% or better diastereoselectivity has turned out to be the general rule for the zinc chloride catalyzed process. Pinanediol methylboronate is an exception, yielding 95% diastereoselectivity. Pinanediol phenylboronate shows the same 97-98% diastereoselectivity with or without the catalyst, but the (s)-pinanediol (1S)-1-chlorobenzylboronate formed in the presence of zinc chloride was easily recrystallized to high chiral purity, in contrast to the intractable oil obtained in the absence of the catalyst (ref. 17).

It might be noted that the zinc chloride catalysis makes our synthesis of (2R,3S)-3-phenyl-2-butanol (**14**) obsolete, since it would presumably be easier to start from (r)-pinanediol methylboronate, homologate to the (1R)-chloroethylboronate, and phenylate to form (r)-pinanediol (1S)-1-phenylethylboronate (**13**) directly, without the need for cleaving one isomer of the pinanediol and replacing it by its enantiomer.

Our results to this point provide a very general controlled chiral synthesis of secondary alcohols, RR'CHOH, and of secondary alcohols containing two adjacent chiral centers, RR'CH-CH(OH)R'', where R, R', and R'' are hydrocarbon groups. As a demonstration of applicability to natural products, we have started from (s)-pinanediol propylboronate (**15**) and synthesized (3S,4S)-4-methyl-3-heptanol (**16**), which is a component of the aggregation pheromone of the elm bark beetle, *Scolytus multistriatus* (ref. 14).

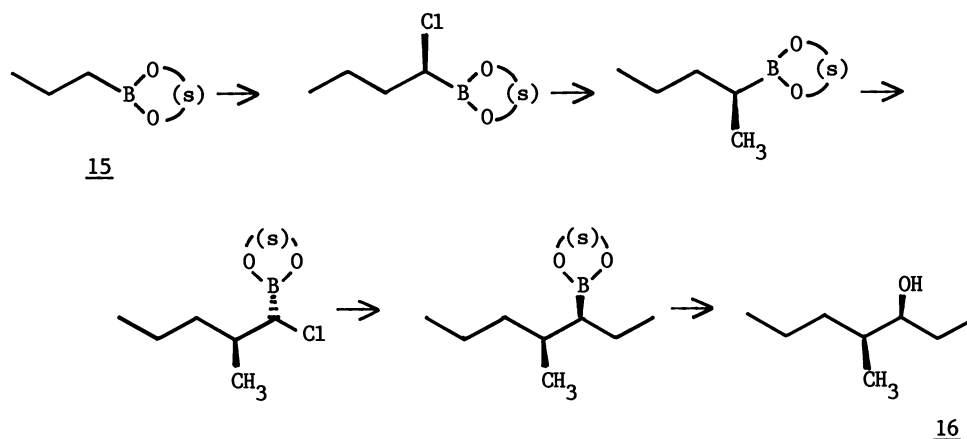

d. Functionalized substrates

For true generality, it is necessary that our synthesis be compatible with the presence of masked functionality. In view of the fact that the homologation of achiral pinacol boronic esters has been carried out in the presence of ether, ketal, and ester functions (ref. 8), it seemed probable that the pinanediol esters would behave similarly. The most crucial question was whether beta-elimination of boron and oxygen would preclude the homologation of alpha-alkoxy boronic esters. This has turned out not to be a problem, as originally shown by the homologation of (s)-pinanediol benzyloxymethylboronate (**3**, R = PhCH₂OCH₂) (ref. 16). The diastereoselectivity in this particular instance could not be determined from the proton NMR spectrum, and it has subsequently been found that a few percent of the (R)-diastereomer are formed (M.L. Peterson, unpublished). However, there appears to be no problem with higher homologues.

As an example of a functionally substituted natural product, we undertook the synthesis of exo-brevicomins (**21**), a component of the aggregation pheromone of the western pine beetle, *Dendroctonus brevicomis*. The starting material was the ethylene ketal of 5-chloro-2-pentanone, which was converted to the Grignard reagent and then the boronic ester **17**. The strategy was designed to test the functional group compatibility of the synthetic method rather than to maximize efficiency, which might have been better accomplished by beginning the synthesis from the opposite end of the molecule with (r)-pinanediol ethylboronate, thus introducing the labile ketal function late in the synthesis. However,

our approach did have the advantage of leading to the same intermediate 20 already described by Sherk and Fraser-Reid for a sugar-based synthesis of brevicomin (ref. 18).

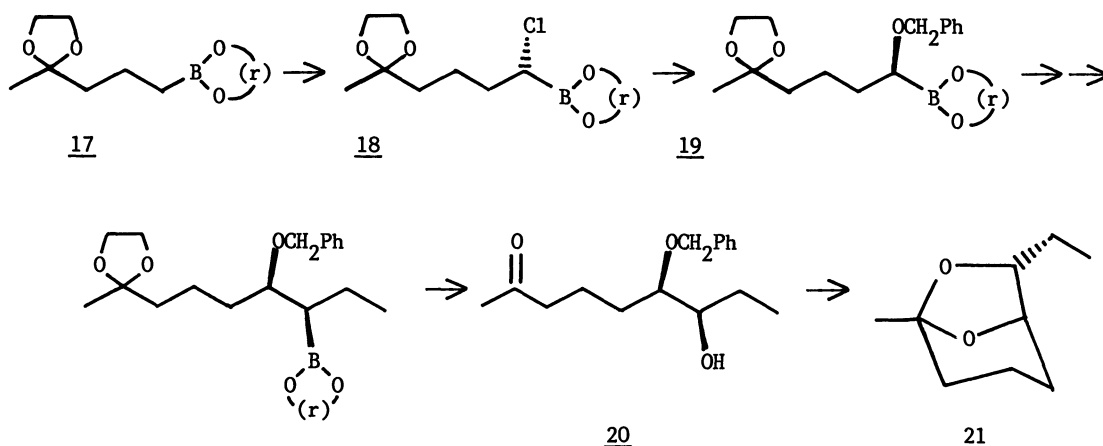

Only minor problems were encountered during the synthesis of 21. Partial hydrolysis of the ketal function during workup was avoided by using saturated ammonium chloride as the aqueous phase. It appeared that a slight amount of epimerization of the chloro boronic ester 19 occurred during treatment with lithium benzyloxide to form 20. The epimer content of the chloro compound 19 was below detectability (0.5%), but the benzyloxy derivative 20 contained 2% epimer by NMR analysis (ref. 14).

It might seem an inefficiency that the foregoing synthesis requires two separate operations in order to introduce the two chiral centers, but there is one distinct advantage. The product necessarily has very high enantiomeric purity, since less than 1% of 2% of the product will have both chiral centers backward (assuming the pinanediol directing group is enantiomerically pure). Thus, the most difficult impurities that have to be separated will be diastereomers. Furthermore, the separate introduction of the two chiral centers allows in principle the free choice of absolute configuration of each one independently of the other, though some further developments in the chemistry will be required in order to realize this possibility. The use of (*R,R*)-2,3-butanediol boronic esters (see following section) offers promise in this regard. Even though chiral aldol condensations offer the alleged efficiency of assembling two chiral centers in one operation, it is first necessary to define the geometry of an enolate, and subsequent operations required in order to remove the chiral directing group and proceed further with the synthesis can be highly complex (ref. 19). Chiral epoxidations create two chiral centers in one step, but again the olefin geometry must first be defined (ref. 20).

The lability of halides beta to a boronic ester group (ref. 3) does not encourage belief that any useful anionic operations could be carried out which lead to beta-haloalkylboronic esters. However, pinanediol 3-chloropropylboronate (22) undergoes efficient homologation with (dichloromethyl)lithium in the normal manner (ref. 16). The synthesis of 22 was easily accomplished by hydroboration of allyl chloride with catecholborane followed by transesterification with pinanediol, though the synthesis was accompanied by formation of 10–25% propylboronic ester.

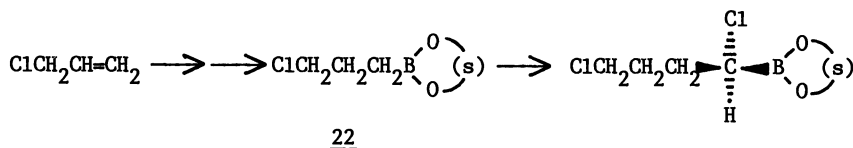

In work in progress with M.L. Peterson and K.M. Sadhu, we are continuing to explore the compatibility of our synthesis with functional substituents. For example, a carboxylic ester group has been found not to impede the homologation, and a simple synthesis of eldanolide, the wing gland pheromone of the African sugar cane borer, has been carried out. This and other syntheses will be reported at a later date.

e. Epimerization and other problems

The problem of epimerization of (*s*)-pinanediol (1*S*)-1-chlorobenzylboronate (9) to form the (1*R*)-isomer (23) was noted briefly in subsection *b*. Although this particular example was controlled by lowering the temperature and time allowed for preparation of the labile 1-chloroboronic ester, this was obviously a general threat to the selectivity of the synthesis, and we have studied the kinetics of the epimerization process in some detail (ref.17).

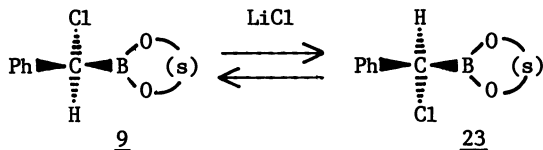

The reaction is first-order in 1-chloro boronic ester (9) and about three-fourths order in lithium chloride, which may be interpreted as half-order plus a salt effect. The pseudo-first-order rate constant at 0.45 M lithium chloride in tetrahydrofuran (nearly saturated) is 0.000057 per second at 25 °C. Pinanediol 1-chloroallylboronate epimerizes 2/3 as fast. A typical saturated 1-chloroalkylboronic ester such as pinanediol 1-chloropentylboronate epimerizes 1/20 as fast. To put this last figure in terms more relevant to the synthetic problem, it may be noted that this amounts to about 1% epimerization per hour for the typical saturated 1-chloroalkylboronic ester, and the rearrangement of the borate precursor generally requires several hours. The observed rates of epimerization are sufficient to account for essentially all of the observed deviation from stereospecificity of the uncatalyzed homologations of pinanediol boronic esters.

All of the data are consistent with free chloride ion being the active epimerization agent. Small amounts of water greatly accelerate the reaction. In the presence of zinc chloride, the epimerization rate is greatly reduced, the minimum being at the composition lithium trichlorozincate. However, excess zinc chloride catalyzes epimerization in a process that is first-order in zinc chloride and first-order in trichlorozincate, and the optimum stoichiometry for synthetic purposes is a final composition corresponding to a mixture of lithium trichlorozincate and dilithium tetrachlorozincate. The epimerization rate is low, 1/3 to 1/10 that without the zinc chloride, and not very sensitive to the salt composition in this range.

One use of the epimerization process is for providing samples in which the epimer can be observed in the NMR spectrum for purposes of analyzing the chiral purity of the 1-chloroalkylboronic ester produced in the homologation process. Not too surprisingly, as the 1-chloroalkylboronic ester becomes more highly branched and sterically hindered the epimerization rate becomes very slow, and several days' exposure to lithium chloride in moist tetrahydrofuran may be required in order to generate a few percent of the epimer for detection purposes (work in progress with K.M. Sadhu and M.L. Peterson).

A different problem encountered with the pinanediol boronic esters arises from the absence of C_2 symmetry in the pinanyl group. As a consequence, it is not possible to start with (*s*)-pinanediol (dichloromethyl)boronate (24), add a Grignard or organolithium reagent, and obtain the same borate complex (4) formed from a pinanediol alkylboronate (3) and (dichloromethyl)lithium. The organometallic reagent always attacks the pinanediol group from the less hindered face, and the borate complex 25, diastereomeric with 4, does not yield diastereomeric ratios sufficiently different from unity to be useful (ref. 21).

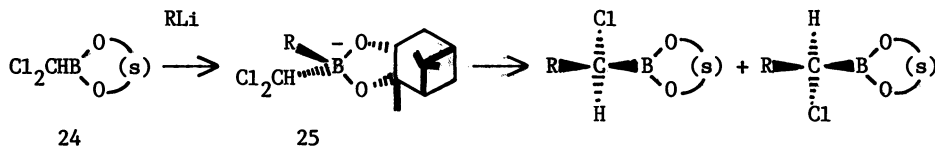

The other problem already noted with the pinanediol esters is their resistance to hydrolysis. Both this and the symmetry problem are overcome by the use of butanediol esters, discussed in the following section. These have other limitations, but the chemist should not expect to solve all problems at once.

(*R, R*)-2,3-BUTANEDIOL ESTERS

The search for chiral directing groups having C_2 symmetry began with diacetone mannitol and tartrate esters, but no useful results were obtained (ref. 12).

(*R,R*)-2,3-Butanediol is a commercially available fermentation product, and its enantiomer can be made from tartrate esters. Treatment of (*R,R*)-2,3-butanediol butylboronate (26, R = Bu) with (dichloromethyl)lithium followed by zinc chloride yielded the (*1S*)-1-chloropentylboronate (29) in 95% diastereomeric purity (ref. 21). The same intermediate borate complex (28) is produced when 2,3-butanediol (dichloromethyl)boronate (27) is treated with butyllithium, and the same diastereomeric purity has been observed in the resulting 29. For the series R = methyl, isopropyl, *n*-butyl, phenyl, or benzyl, the diastereoselectivity was uniformly 95-96%, with one exception (91%) attributed to operator inexperience.

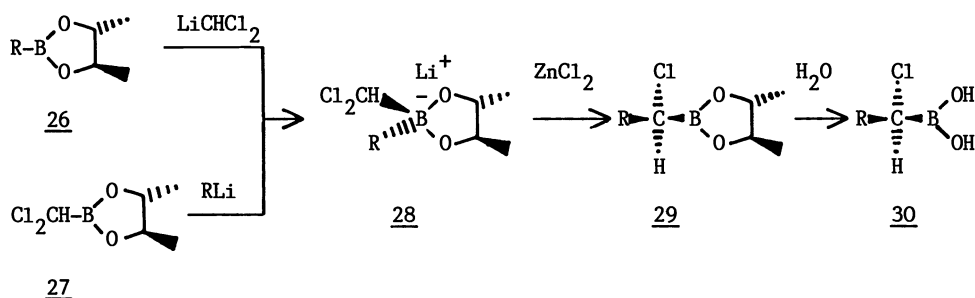

(*R,R*)-2,3-Butanediol (dichloromethyl)boronate 27 is an easily prepared and storable reagent. It is potentially widely useful for the synthesis of chiral secondary alcohols, since the (*1S*)-1-chloroalkylboronic esters (29) obtained from 27 and alkylolithium or Grignard reagents will react in the same manner as other 1-chloroalkylboronic esters with a second lithium or Grignard reagent. The configuration of the resulting chiral center is dependent on the order of introduction of the groups according to well defined rules.

Although the mere 95% diastereoselectivity might seem a disadvantage, two examples of 29 (R = isopropyl, benzyl) were hydrolyzed to the boronic acids (30), which were shown to be enantiomerically purifiable by recrystallization in each case. It would be of special interest to obtain enantiomerically pure (*1S*)-1-chloroethylboronic acid (30, R = methyl), but only poor yields of this boronic acid have been obtained by water/ether partitioning of dilute solutions of 29, and recrystallization has proved difficult (G.D. Hurst, unpublished results). Another difficult case has been R = allyl. The addition of allylmagnesium chloride to 27 has resulted in about 70% diastereoselectivity in formation of 29 and has also yielded a substantial proportion of bis(allyl)methylboronic ester, even with a deficiency of allylmagnesium chloride (J.D. Campbell, unpublished results). Other simple extensions of the published work have gone routinely.

It should be readily apparent that the ease of hydrolysis of the butanediol group can provide a solution to the problem of changing the chiral directing group if necessary before installation of a second chiral center.

AMIDO BORONIC ACIDS

Amido boronic acids are peptide analogues of interest as inhibitors of enzymes, especially serine proteases, that catalyze reactions involving conversion of carbonyl carbon to tetra-coordinate carbon intermediates. The stable tetra-coordinate boron analogue tends to bind strongly to the enzyme. An example is the *N*-acetylphenylalanine analogue (32), an inhibitor of chymotrypsin, which was synthesized via the bis(trimethylsilyl)amino intermediate 31 (ref. 22).

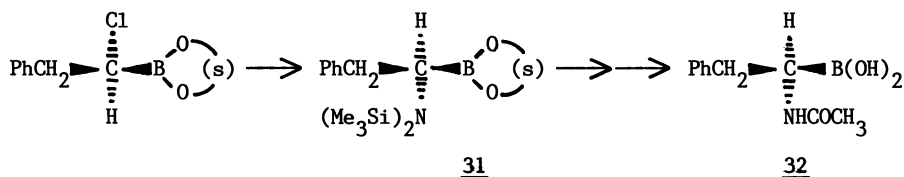

It is necessary to use the silylated amino intermediate 31 because amino boronic esters are unstable and undergo deboronation during attempted isolation. The fact that lithiohexamethyldisilazane efficiently displaces chloride from 1-chloroalkylboronic esters illustrates the lack of sensitivity of displacements on these compounds to steric hindrance.

CONCLUSION

Our new directed chiral synthesis based on boronic ester chemistry allows the sequential introduction of adjacent chiral centers with excellent control of the absolute configuration of each independently, and is compatible with masked functionality. The new method has wide ranging synthetic potential, and we are actively pursuing a variety of applications.

ACKNOWLEDGMENT

We thank the National Science foundation for grants CHE-8025229 and CHE-8400715, the U.S. Public Health Service for grant GM27109, and the Boeing Corporation for a departmental gift in support of the 200 MHz NMR instrument.

REFERENCES

1. D.S. Matteson, *J. Am. Chem. Soc.*, **82**, 4228-4233 (1960).
2. D.S. Matteson and R.W.H. Mah, *J. Am. Chem. Soc.*, **85**, 2599-2603 (1963).
3. D.S. Matteson, *Accounts Chem. Res.*, **3**, 186-193 (1970).
4. (a) H.C. Brown, N.R. De Lue, Y. Yamamoto, and K. Maruyama, *J. Org. Chem.*, **42**, 3252-3254 (1977). (b) H.C. Brown, N.R. De Lue, Y. Yamamoto, K. Maruyama, T. Kasahara, S. Murahashi, and A. Sonoda, *J. Org. Chem.*, **42**, 4088-5092 (1977).
5. G. Köbrich, K. Flory, and W. Drischel, *Angew. Chem., Internat. Ed.*, **3**, 513 (1964).
6. G. Köbrich and H.R. Merkle, *Angew. Chem., Internat. Ed.*, **6**, 74 (1967).
7. M.W. Rathke, E. Chao, and G. Wu, *J. Organomet. Chem.*, **122**, 145-149 (1976).
8. (a) D.S. Matteson and D. Majumdar, *J. Am. Chem. Soc.*, **102**, 7588-7590 (1980). (b) D.S. Matteson and D. Majumdar, *Organometallics*, **2**, 1529-1535 (1982).
9. H.C. Brown and G. Zweifel, *J. Am. Chem. Soc.*, **83**, 486-487 (1961).
10. (a) R. Ray and D.S. Matteson, *Tetrahedron Lett.*, **21**, 449-450 (1980). (b) R. Ray and D.S. Matteson, *J. Indian Chem. Soc.*, **59**, 119-123 (1982).
11. V. Van Rheenen, R.C. Kelly, and D.Y. Cha, *Tetrahedron Lett.*, 1973-1976 (1976).
12. (a) D.S. Matteson and R. Ray, *J. Am. Chem. Soc.*, **102**, 7590-7591 (1980). (b) D.S. Matteson, R. Ray, R.R. Rocks, and D.J. Tsai, *Organometallics*, **2**, 1536-1543 (1982).
13. Aldrich Chemical Company, P.O. Box 355, Milwaukee, Wisconsin 53201, U.S.A.
14. D.S. Matteson and K.M. Sadhu, *J. Am. Chem. Soc.*, **105**, 2077-2078 (1983); correction (identification of tabulated compounds), 6195 (1983).
15. (a) D.J. Cram, *J. Am. Chem. Soc.*, **71**, 3863-3870 (1949). (b) D.J. Cram, *J. Am. Chem. Soc.*, **74**, 2149-2151 (1952).
16. D.S. Matteson, P.K. Jesthi, and K.M. Sadhu, *Organometallics*, **3**, 1284-1288 (1984).
17. D.S. Matteson and E. Erdik, *Organometallics*, **2**, 1083-1088 (1983).
18. A.E. Sherk and B. Fraser-Reid, *J. Org. Chem.*, **47**, 932-935 (1982).
19. (a) D.A. Evans, J.V. Nelson, and T.R. Taber, *Topics in Stereochemistry*, N.L. Allinger, E.L. Eliel, and S.H. Wilen, Eds., v. 13, p. 1-116, Wiley, New York (1982). (b) S. Masamune, T. Kaiho, and D.S. Garvey, *J. Am. Chem. Soc.*, **104**, 5521-5523 (1982).
20. K.B. Sharpless, C.H. Behrens, T. Katsuki, A.W.M. Lee, V.S. Martin, M. Takatani, S.M. Viti, F.J. Walker, and S.S. Woodard, *Pure Appl. Chem.*, **55**, 589-604 (1983).
21. K.M. Sadhu, D.S. Matteson, G.D. Hurst, and J.M. Kurosky, *Organometallics*, **3**, 804-806 (1984).
22. (a) D.S. Matteson, K.M. Sadhu, and G.E. Lienhard, *J. Am. Chem. Soc.*, **103**, 5241-5242 (1981). (b) D.S. Matteson and K.M. Sadhu, *Organometallics*, **3**, 614-618 (1984).