

## From silabenzene to cyclopropenylidene

Günther Maier

Institut für Organische Chemie der Justus-Liebig-Universität, Gießen, Germany

**Abstract** - Isolation and identification of a number of highly reactive species are described. The main route for their preparation involves the combination of flash pyrolysis and matrix isolation in argon at 10 K. This article covers hetero- $\pi$ -systems like silabenzene, silaethene, 1,4-disilabenzene, derivatives of borabenzene and boraethene as well as pure carbocyclic compounds with peculiar electronic characteristics. In this context some new aspects of cyclobutadiene-, tetrahedrane- and cyclopentadienone-chemistry are discussed. The main emphasis within this part is directed towards the  $C_4H_4$  potential surface. The article ends with a short comment on cyclopropenylidene.

### A SILABENZENE AND RELATED COMPOUNDS

If it is true that silabenzene (3) is characterized by a considerable delocalization energy (ref. 1), then the molecule should be isolable in an argon matrix at very low temperature. With this in mind we subjected 1, 2 (ref. 2) and 4 to flash pyrolysis and condensed the products together with argon onto a window at 10 K. In all cases we were able to trap silabenzene (3) as shown by a characteristic

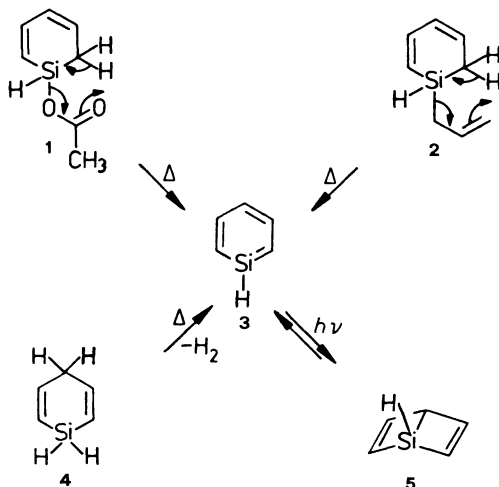

Si-H stretching vibration of 3 at  $2217\text{ cm}^{-1}$  (for hydrogen attached to a  $sp^2$ -hybridized silicon atom wave numbers higher than  $2200\text{ cm}^{-1}$  can be expected) and a typical benzene-type UV spectrum (ref. 3). Starting with 4 all PES bands of silabenzene could be measured (ref. 4). In conclusion one has to note that silabenzene (3) is best considered as a symmetry-distorted delocalized  $6\pi$ -electron system.

Silabenzene 3 can be transformed into Dewarsilabenzene (5) photochemically (320 nm); use of a shorter wave length (240 nm) leads back to 3.

Encouraged by the successful matrix isolation of silabenzene, we ventured to approach unsubstituted silaethene (7). Using the same techniques with 6 as the precursor it was possible (ref. 5) to isolate 7 and to identify this highly reactive molecule

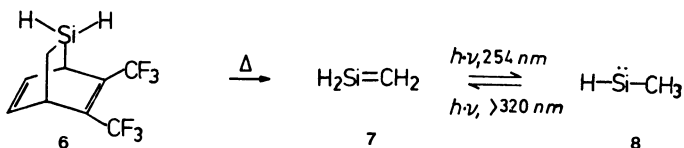

by IR and UV spectroscopy. Matrix irradiation (254 nm) of 7 gives methylsilene 8; the back reaction can also be induced photochemically (>320 nm) (ref. 6).

Knowing that 1-sila-2,5-cyclohexadiene (4) yields silabenzene (3) so easily, it was only logical to try to dehydrogenate 1,4-disila-2,5-cyclohexadiene (9) (ref. 7) under similar conditions. Flash pyrolysis of 9 combined with matrix isolation allo-

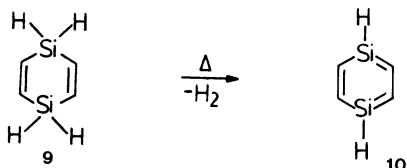

wed the preparation (although this reaction is much less effective than dehydrogenation of 4) and identification of 1,4-disilabenzene (10) by its characteristic UV-spectrum. There is a strong bathochromic shift on going from benzene via silabenzene (3) to disilabenzene (10) (ref. 8).

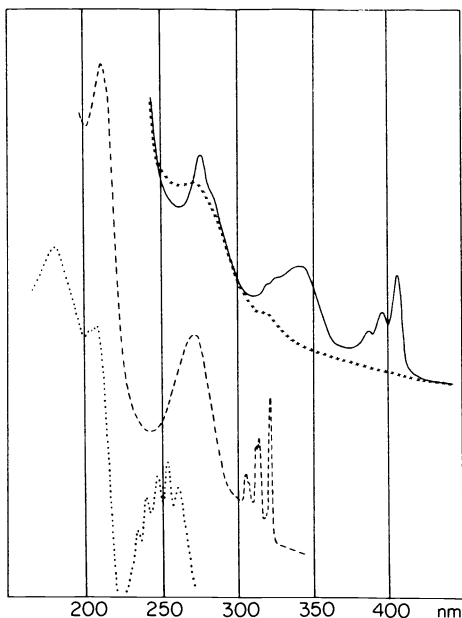
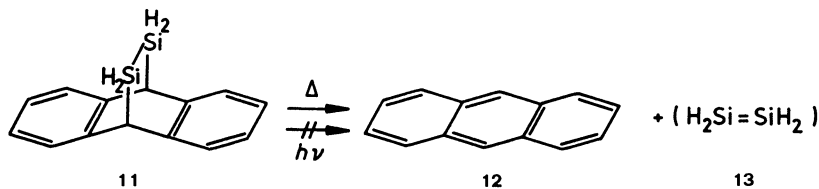

Fig. 1. UV spectra of benzene (.....), silabenzene (3) (-----) and 1,4-disilabenzene (10) (———). After irradiation (10 min,  $\lambda = 405$  nm) the bands of 10 have disappeared (xxxxx). The extinction coefficients of 3 and 10 cannot be given for methodological reasons. The spectrum of benzene is recorded on a logarithmic scale.

In view of the sequence silabenzene (3) / disilabenzene (10) it seemed attractive to complete our efforts in the area of silaethenes by the preparation of the parent disilene (13). The promising precursor 11 could be prepared (ref. 9). This compound is photostable, and after pyrolysis only anthracene (12) could be detected as the matrix-isolated product. Perhaps disilene (13) is formed, but this molecule adheres to the



walls of the hot tube and cannot pass the oven. Our experience indicates that this effect is one of the big drawbacks in attempts to prepare "naked" compounds containing silicon (or boron) double bond systems.

## B BORABENZENE AND RELATED COMPOUNDS

Is it possible to use the retro-ene reaction to prepare borabenzene (14)? In spite of the expected extremely high reactivity of 14 due to its high acceptor strength at the unsubstituted  $\pi$ -bonded boron atom we hoped to get 14 by thermal degradation of allylboracyclohexadiene 15 (ref. 10). The unconjugated isomer could be synthesized by routine methods. On flash

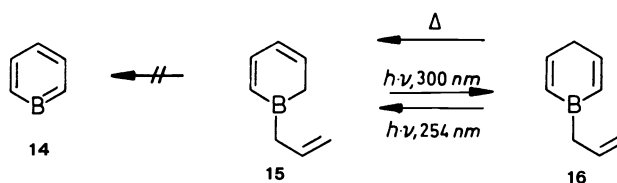

pyrolysis ( $800^{\circ}\text{C}$ ) 16 isomerizes into the wanted 1-allyl-1-bora-2,4-cyclohexadiene (15) which can be trapped in argon at 10 K. Borabenzene (14) is not formed under these conditions. By using photochemical means it is possible to isomerize matrixisolated 15 into 16; the back reaction can be achieved by using a different wave length.

So it is quite obvious that pyrolysis of 15 is not the method of choice for the preparation of borabenzene. This finding is not too surprising: In 15 we have a planar arrangement around the boron atom. Therefore the prerequisites for a retro-ene cleavage are bad.

A much better candidate as starting material would be 1-methoxy-6-trimethylsilyl-1-bora-2,4-cyclohexadiene (18). Combination of flash pyrolysis with matrix isolation allows the identification of methoxytrimethylsilane as the only fragment. So it is clear that 18 undergoes a splitting on thermolysis into 14 and 17, but borabenzene seems to be so reactive, that it does not pass the hot tube. In other words, one has to find a milder method for the elimina-

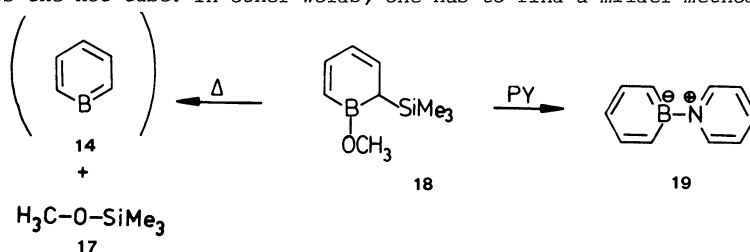

tion of 17. It turns out that this reaction occurs very cleanly when precursor 18 is treated with pyridine (ref. 11). One isolates a crystalline yellow compound with structure 19. At present this betaine is the molecule closest to unsubstituted borabenzene (14).

The X-ray structure analysis as well as the NMR signals of pyridine-borabenzene (19) (ref. 11) prove the aromatic character of the borabenzene ring. The pyridine and borabenzene rings are at an angle of  $43.3^{\circ}$  to one another. An additional characteristic feature of 19 is a charge transfer band at 472 nm.

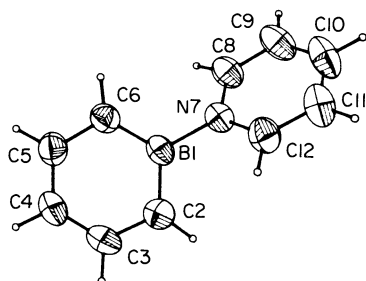
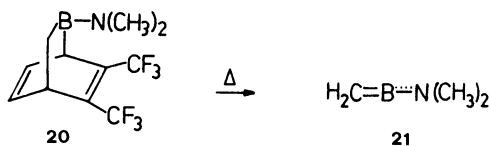

Fig. 2. Molecular structure of pyridine-borabenzene (19).

The interest in B,C- $\pi$ -systems is just starting (ref. 12). As in the silicon case we tried to use the same kind of starting material for the synthesis of the heterobenzene on the one hand and the heteroethylene on the other. Using our routine technique we studied the thermal behaviour of the bicyclic compound 20. Flash pyrolysis resulted in a clean fragmentation of



20 into hexafluoro-*o*-xylene and a species, which from its matrix IR spectrum [bands at  $1829.5$  and  $1780.8\text{ cm}^{-1}$  in the ratio 1 : 4 for  $\nu_{\text{as}}(N^{10}\text{BC})$  and  $\nu_{\text{as}}(N^{11}\text{BC})$ ] has to be 1-dimethylamino-1-boraethene (21) with an allene type structure.

## C CYCLOBUTADIENES/TETRAHEDRANES/CYCLOPENTADIENONES

### a Tri-*tert*-butylated compounds

Why do I mention tri-*tert*-butylcyclobutadiene, such an old-fashioned (ref. 13) compound? There are at least three recent observations which deserve a short comment.

1. It was in the case of the deuteriated derivative  $\underline{\underline{22}}\text{-D}_9$  that the first direct spectroscopic (ref. 14) evidence for the valence tautomeric relationship in cyclobutadiene could be reported (ref. 15).

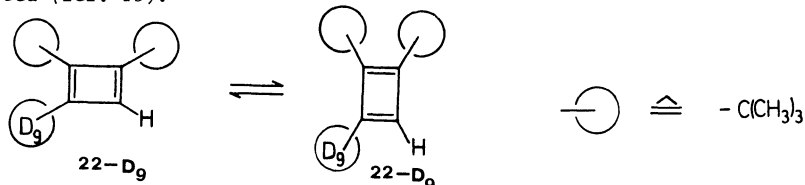

2. Highly substituted cyclobutadienes like  $\underline{\underline{22}}$  and  $\underline{\underline{23}}$ , as well as the electronically related cyclopentadienones (ref. 16)  $\underline{\underline{24}}$  and  $\underline{\underline{25}}$ , show broad signals in the ESR spectrum. It is still not clear which species cause the ESR absorptions.

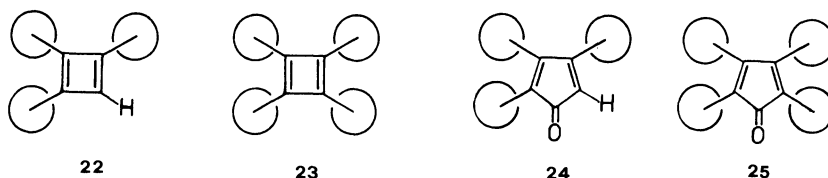

The pattern (Fig. 3 shows the spectrum of cyclobutadiene  $\underline{\underline{23}}$ ) does not fit with the spectra expected for triplet molecules.

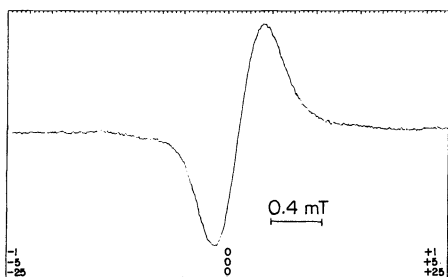
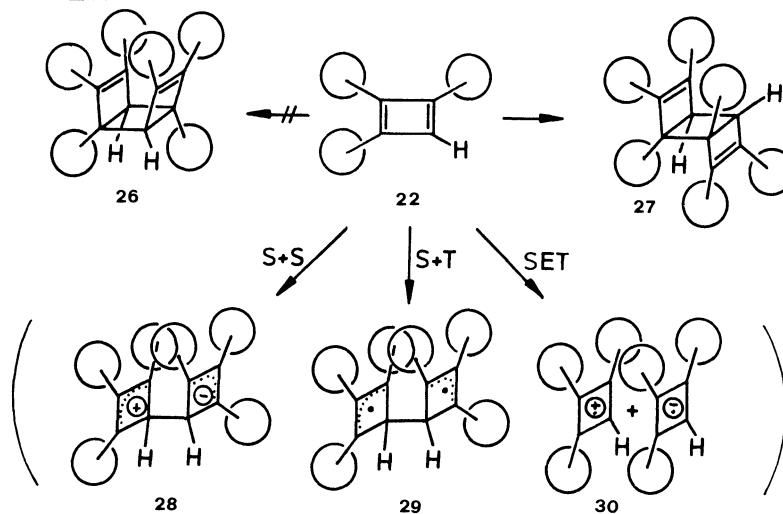

Fig. 3. ESR spectrum of tetra-*tert*-butylcyclobutadiene ( $\underline{\underline{23}}$ ).

3. As shown by an X-ray structure determination (ref. 17) the dimerization of  $\underline{\underline{22}}$  does not lead to the *syn*-dimer  $\underline{\underline{26}}$  (ref. 18). The tricyclic compound  $\underline{\underline{27}}$  with an *anti*-configuration is formed instead, *via* a two-step process. It is difficult to rationalize this surprising re-



sult. The first step could be a nucleophilic addition of singlet- $\underline{\underline{22}}$  to singlet- $\underline{\underline{22}}$  (intermediate  $\underline{\underline{28}}$ ), the reaction between singlet- $\underline{\underline{22}}$  and some thermally populated triplet- $\underline{\underline{22}}$  (intermediate  $\underline{\underline{29}}$ ) or a single electron transfer forming a radical ion pair  $\underline{\underline{30}}$  by "self-ionization" of cyclobutadiene  $\underline{\underline{22}}$ . The last mentioned route would fit with the ESR results. Recombination of the radical ions could give either  $\underline{\underline{28}}$  or  $\underline{\underline{29}}$  and finally dimer  $\underline{\underline{27}}$ .

## b Tetra-*tert*-butylated compounds

Under normal conditions tetra-*tert*-butyltetrahedrane (33) is stable against oxygen and water. However, as soon as an electron-acceptor is added 33 becomes very reactive (ref. 19). This effect is due to the easy oxidation of tetra-*tert*-butyltetrahedrane (33) and/or tetra-*tert*-butylcyclobutadiene (23) (ref. 20). Three recent results from this field are worthy of notice:

1. Heating of tetrahedrane 33 (130°C) brings about quantitative isomerization to cyclobutadiene 23. Irradiation regenerates 33 (ref. 21). It is not possible to catalyze the thermal transformation 33 → 23 by Ag<sup>+</sup> ions. They only oxidize tetrahedrane (see below). The ideal method

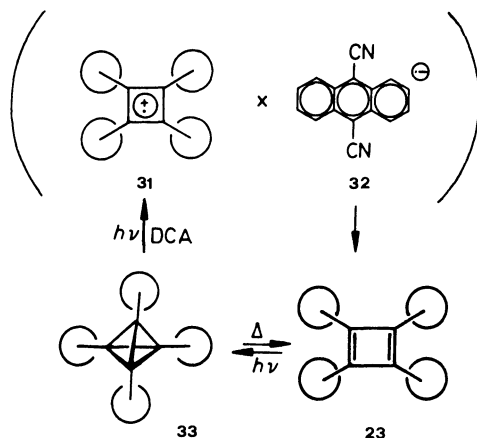

for converting 33 into 23 under mild conditions in quant. yields is the irradiation of tetrahedrane 33 in the presence of dicyanoanthracene. This reaction probably occurs via radical ion pair 31/32.

2. The above mentioned reaction of tetrahedrane 33 or cyclobutadiene 23 with Ag<sup>+</sup> ions yields stable crystalline cyclobutenylium ions of type 34 and 36. Both compounds may be formed by initial addition of water to radical cation 31. The resulting adduct 35 is either able to protonate 33 or 23 with formation of the H-salt 34, or can be oxidized 35 by an excess of Ag<sup>+</sup>

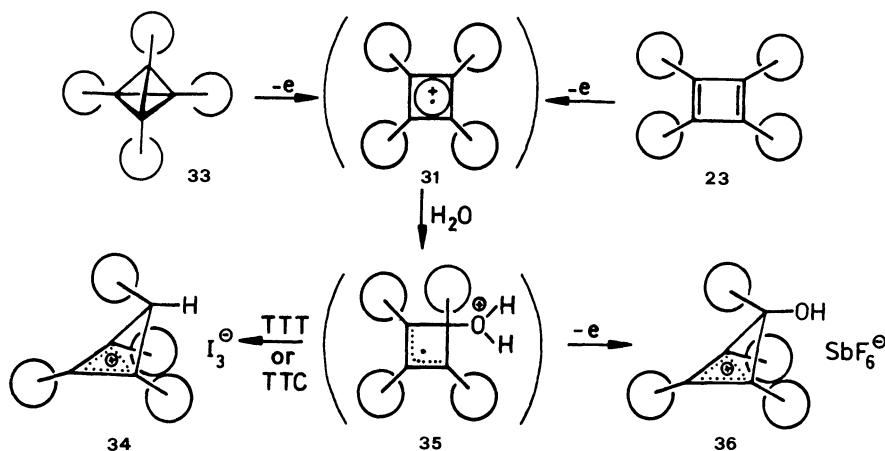

ions to HO-salt 36 (ref. 22). The spectroscopic properties, and especially the crystal structure determination of 34 and 36 (Fig. 4) (ref. 22), show the characteristics for homocyclopropenylium salts (ref. 23). Because of 1,3-bonding interactions the ions are folded (34: 37.3°, 36: 36.4°), and the 1,3-distances across the four-membered ring are short (34: 1.806 Å, 36: 1.833 Å).

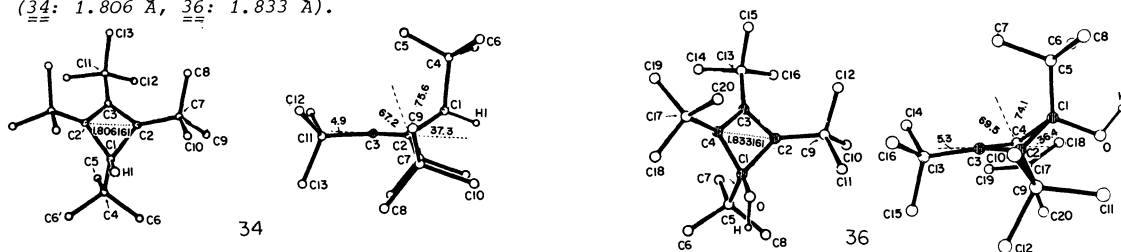
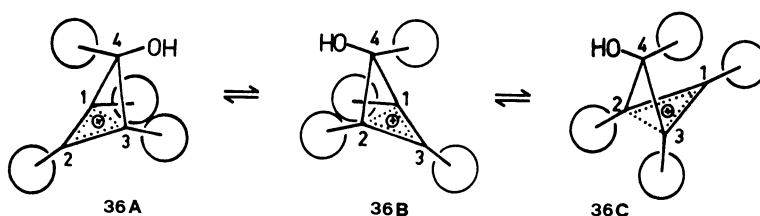

Fig. 4. Molecular structures of cyclobutenylium ions 34 and 36.

3. The NMR spectrum of ion 36 is temperature dependent (ref. 24). The reversible changes in the spectra demand a dynamic process in which the olefinic ring positions are equilibrated, while the  $sp^2$  type ring carbon and the substituents attached to it do not, however, experience any change. The simplest interpretation of this process is the occurrence of the walk



rearrangement 36 A  $\rightleftharpoons$  36 B  $\rightleftharpoons$  36 C (ref. 25).

The stereochemistry of this process is of particular interest, since according to theory (ref. 26) one expects in this case a violation of the Woodward-Hoffmann rules (36  $\rightarrow$  37  $\rightarrow$  36 preferred compared to 36  $\rightarrow$  38  $\rightarrow$  39).

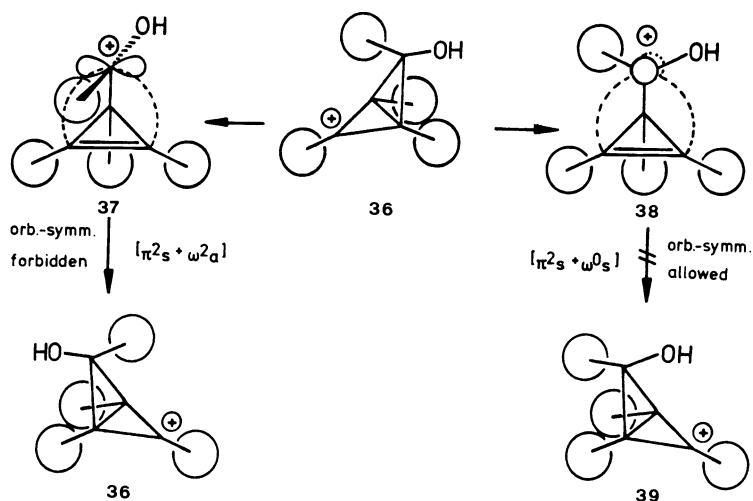

### c Unsubstituted parent compounds

As in the case of silabenzene our interest in the unsubstituted tetrahedrane originates from the lecture delivered by M.J.S.Dewar at the ISNA II meeting in Lindau (ref. 1), in which he proposed that tetrahedrane may eventually be stable enough to be isolated in a matrix at 10 K. So in connection with our former interest in cyclobutadiene we started a project covering as many different entries into the  $C_4H_4$  energy surface (ref. 27) as possible, hoping that one of them would lead to tetrahedrane. Today I want to draw your attention to examples,

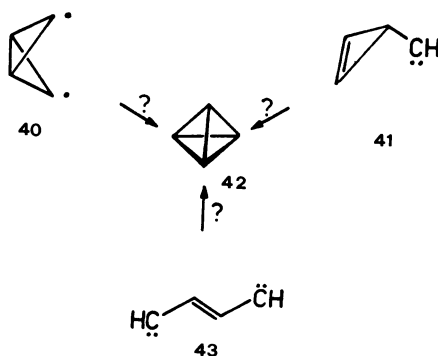

where we tried to construct the tetrahedrane skeleton 42 via diradical 40, cyclopropenylcarbene 41 or dicarbene 43.

Potential candidates for the photochemical or thermal generation of tetrahedrane (42) are 44 (ref. 28), 45 (ref. 29), 46 (ref. 30), 47 (ref. 31) and 49 (ref. 32). Tetrahedrane was not detected when these precursors were subjected either to the combination flash pyrolysis / matrix isolation or to matrix irradiation (ref. 33).

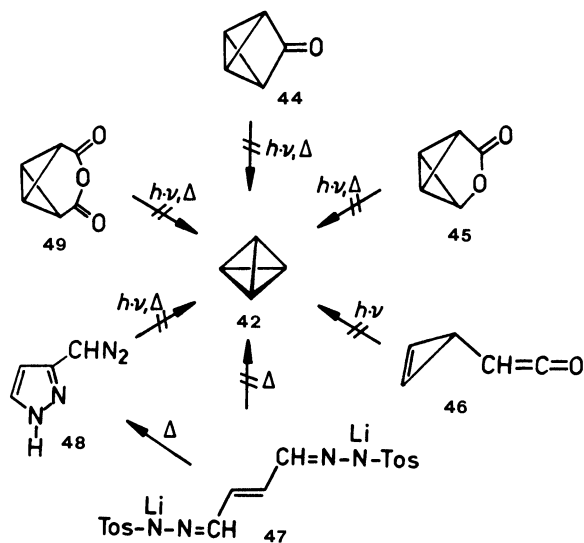

The same is true for the dilithium salt 47 which was used by Rodewald and Lee (ref. 34) in their attempts to find an indirect proof for the existence of 42. Under our conditions we isolated diazocompound 48 as the only definite fragment in the pyrolysis of 47. Again, independently synthesized diazo derivative 48 did not lead to tetrahedrane, and only acetylene and vinylacetylene could be identified on matrix irradiation of 48.

If one is looking for tetrahedrane it is disappointing if only cyclobutadiene (53) is found. That is what really happens in the reactions shown in the scheme which includes some starting materials already mentioned (ref. 30) and in addition precursors 50, 51 and 52. Our results support the earlier postulate made by Hedaya (ref. 35), that flash pyrolysis of photo- $\alpha$ -pyrone gives cyclobutadiene (ref. 36) and that the lifetime of this transient intermediate is only a few ms. There is now a whole list of compounds which allow the thermal formation and matrix isolation of cyclobutadiene. This is even possible by starting with an open chain precursor like 52!

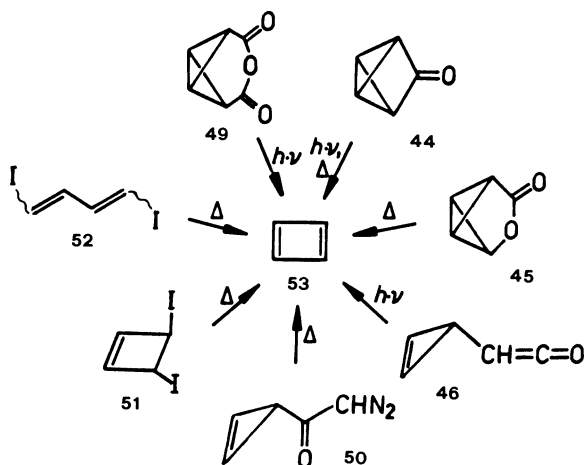

Another  $C_4H_4$  isomer is methylenecyclopropene (54). This compound has been described very recently by Billups (ref. 37) and Staley (ref. 38). In an independent study we have found that methylene cyclopropene is also one of the products in the flash pyrolysis of 50 and

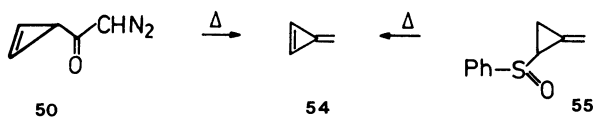

and 55 (ref. 39). This confirms Neuenschwander's trapping studies (ref. 39) with 54 (ref. 40).

Since the cyclopentadienone molecule poses problems resembling those considered for cyclobutadiene (ref. 13a) this section will be concluded with a few remarks about this unusual ketone (ref. 41). It was in 1971 (ref. 42) that the IR spectroscopic detection of 62 was reported. The spectrum reported was in contradiction to our own results which we got 62 from studies directed towards the synthesis of 62 from a whole list of suitable precursors (44, 49, 50, 56 - 61). In all cases cyclopentadienone 62 can be generated by photochemical and/or

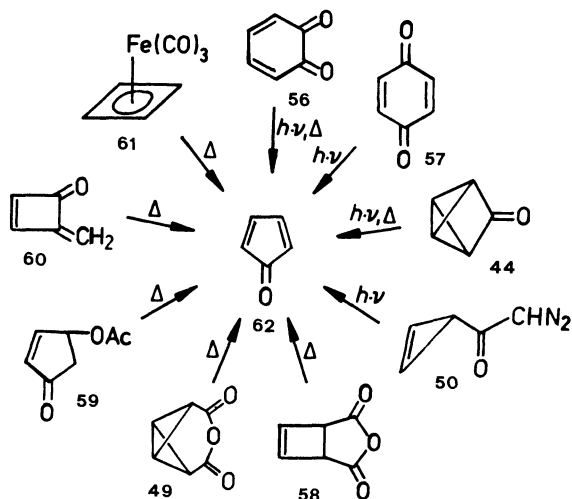

pyrolytic means and isolated in an argon matrix. It dimerizes even on thawing of the matrix (38 K). The IR spectrum of 62, prepared by flash pyrolysis of *o*-benzoquinone, is shown in Fig. 5 (ref. 43).

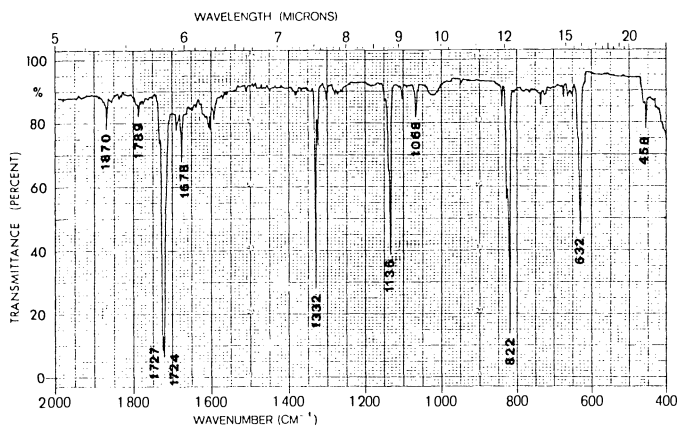

Fig. 5. IR-spectrum of cyclopentadienone (62) in argon at 10 K

The UV spectrum of 62 with two maxima at 195 and 360 nm is in good agreement with the theoretical predictions [184 (ref. 44), 310-380 (ref. 44, 45) nm]. Both bands result from  $\pi \rightarrow \pi^*$  transitions.

Summarizing all the information available (ref. 41) one can say: Cyclopentadienone (62) is in its ground state properties (PE, NMR, IR spectra; dipole moment, bond alternation) a "normal"  $\alpha, \beta$ -unsaturated ketone. The unusual behaviour (UV spectra, redox characteristics, Diels-Alder reactivity) is dominated by the strongly delocalized and therefore energetically low-lying LUMO. In this respect the similarity with cyclobutadiene is obvious.



## D CYCLOPROPENYLIDENE

In accordance with the title of this conference it seems appropriate to begin - as I did with silabenzene - and to end with an aromatic molecule. So I want to conclude with cyclopropenylidene (64) (ref. 46). The resonance  $\underline{64a} \leftrightarrow \underline{64b}$  symbolizes why this molecule should have a singlet ground state. In cooperation with R.W. Hoffmann we prepared 64 by flash pyrolysis of quadricyclane derivative 65 (ref. 47). Ring opening followed by cleavage of norborn-

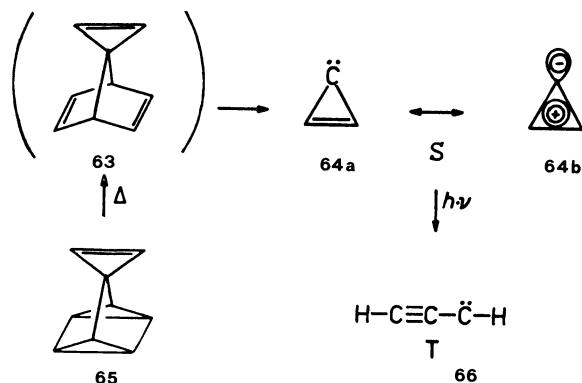

nadiene 63 yields cyclopropenylidene 64. The IR spectrum of the matrix isolated product showed, apart from the bands from benzene, four additional absorptions. The frequencies and intensities of those four most intense IR bands were consistent with the calculated spectrum for 64 (ref. 48).

Upon irradiation ( $\lambda > 360$  nm) of the matrix-isolated products only the four bands belonging to 64 disappear and new absorptions, whose frequencies correspond to the known propynylidene (66) (ref. 49) can be observed.

As expected the ESR spectrum of 64 shows no triplet signal, but after irradiation the typical spectrum of triplet carbene 66 (ref. 50) is obtained.

So, "aromatic" cyclopropenylidene 64 is stable in an argon matrix at 10 K and has, as predicted, a singlet ground state.

## REFERENCES

1. M.J.S. Dewar, Lecture at the ISNA II Meeting at Lindau, 1974; *Pure Appl. Chem.* **44**, 767 (1975).
2. Procedure as in the synthesis of silatoluene: T.J. Barton, G.T. Burns, *J. Am. Chem. Soc.* **100**, 5246 (1978).
3. G. Maier, G. Mihm, H.P. Reisenauer, *Angew. Chem.* **92**, 58 (1980); *Angew. Chem., Int. Ed. Engl.* **19**, 52 (1980). - G. Maier, G. Mihm, H.P. Reisenauer, *Chem. Ber.* **115**, 801 (1982). - G. Maier, G. Mihm, R.O.W. Baumgärtner, *Chem. Ber.* **117**, 2337 (1984).
4. Hans Bock, P. Rosmus, B. Solouki, G. Maier, *J. Organomet. Chem.* **271**, 145 (1984).
5. G. Maier, G. Mihm, H.P. Reisenauer, *Angew. Chem.* **93**, 615 (1981); *Angew. Chem., Int. Ed. Engl.* **20**, 597 (1981). - G. Maier, G. Mihm, H.P. Reisenauer, *Chem. Ber.* **117**, 2351 (1984).
6. H.P. Reisenauer, G. Mihm, G. Maier, *Angew. Chem.* **94**, 864 (1982); *Angew. Chem., Int. Ed. Engl.* **21**, 854 (1982). - G. Maier, G. Mihm, H.P. Reisenauer, D. Littmann, *Chem. Ber.* **117**, 2369 (1984).
7. E.A. Chernyshev, N.G. Komalenkova, S.A. Bashkirova, V.V. Sokolov, *Zh. Obshch. Khim.* **48**, 830 (1978).
8. G. Maier, K. Schöttler, H.P. Reisenauer, *Tetrahedron Lett.*, in print.
9. D. Littmann, dissertation, Univ. Gießen 1985.
10. J. Henkelmann, diploma work, Univ. Gießen 1982.
11. R. Boese, N. Finke, J. Henkelmann, G. Maier, P. Paetzold, H.P. Reisenauer, G. Schmid, *Chem. Ber.* **118**, 1644 (1985).
12. H. Nöth, B. Glaser, *Angew. Chem.* **97**, 424 (1985); *Angew. Chem., Int. Ed. Engl.* **24**, 416 (1985); references cited therein.
13. Summaries: a) G. Maier, *Angew. Chem.* **86**, 491 (1974); *Angew. Chem., Int. Ed. Engl.* **13**, 425 (1974). - b) T. Bally, S. Masamune, *Tetrahedron* **36**, 343 (1980).
14. For a kinetic study see: D.W. Whitman, B.K. Carpenter, *J. Am. Chem. Soc.* **102**, 4272 (1980).
15. G. Maier, H.-O. Kalinowski, K. Euler, *Angew. Chem.* **94**, 706 (1982); *Angew. Chem., Int. Ed. Engl.* **21**, 693 (1982).

16. H.-O. Kalinowski, L.H. Franz, G. Maier, Org. Magn. Res. **17**, 6 (1981).
17. G. Maier, K. Euler, H. Irngartinger, M. Nixdorf, Chem. Ber. **118**, 409 (1985).
18. G. Maier, A. Alzérreca, Angew. Chem. **85**, 1056 (1973); Angew. Chem., Int. Ed. Engl. **12**, 1015 (1973). - G. Maier, W. Sauer, Angew. Chem. **87**, 675 (1975); Angew. Chem., Int. Ed. Engl. **14**, 648 (1975).
19. G. Maier, K.-A. Schneider, K.-D. Malsch, H. Irngartinger, A. Lenz, Angew. Chem. **94**, 446 (1982); Angew. Chem., Int. Ed. Engl. **21**, 437 (1982).
20. H. Bock, B. Roth, G. Maier, Angew. Chem. **92**, 213 (1980); Angew. Chem., Int. Ed. Engl. **19**, 209 (1980). - H. Bock, B. Roth, G. Maier, Chem. Ber. **117**, 172 (1984). - M. A. Fox, K. A. Campbell, S. Hünig, H. Berneth, G. Maier, K.-A. Schneider, K.-D. Malsch, J. Org. Chem. **47**, 3408 (1982).
21. G. Maier, S. Pfriem, U. Schäfer, R. Matusch, Angew. Chem. **90**, 552 (1978); Angew. Chem., Int. Ed. Engl. **17**, 520 (1978). - G. Maier, S. Pfriem, U. Schäfer, K.-D. Malsch, R. Matusch, Chem. Ber. **114**, 3965 (1981).
22. G. Maier, R. Emrich, K.-D. Malsch, K.-A. Schneider, M. Nixdorf, H. Irngartinger, Chem. Ber. **118**, 2798 (1985).
23. A tetraphenylsubstituted cyclobutenylium salt is nearly planar [E. Hey, F. Weller, K. Dehnicke, Z. Anorg. Allg. Chem. **502**, 45 (1983)], a tetramethylated derivative, in which the anion is still bonded to the four-membered ring [C. Krüger, P. J. Roberts, Y.-H. Tsay, J. B. Koster, J. Organomet. Chem. **78**, 69 (1974)], shows a geometry very similar to 34 and 36.
24. G. Maier, R. Emrich, H.-O. Kalinowski, Angew. Chem. **97**, 427 (1985); Angew. Chem., Int. Ed. Engl. **24**, 429 (1985).
25. Such an isomerization is known in the case of methyl-substituted homocyclopropenylium salts: V.A. Koptuyug, I.A. Shleider, I.S. Isaev, J. Org. Chem. USSR **7**, 864 (1971). - I.A. Shleider, I.S. Isaev, V.A. Koptuyug, ibid **8**, 1357 (1972).
26. a) ab initio: W.A. Hehre, A.J.P. Devaquet, J. Am. Chem. Soc. **98**, 4370 (1976); ibid. **96**, 3644 (1974). - b) MINDO/2: K. Morio, S. Masamune, Chem. Lett. **1974**, 1251.
27. H. Kollmar, F. Carrion, M.J.S. Dewar, R.C. Bingham, J. Am. Soc. **103**, 5292 (1981).
28. G. Maier, M. Hoppe, H.P. Reisenauer, Angew. Chem. **95**, 1009 (1983); Angew. Chem., Int. Ed. Engl. **22**, 990 (1983).
29. E.J. Corey, W.H. Pirkle, Tetrahedron Lett. **1967**, 5255.
30. G. Maier, M. Hoppe, K. Lanz, H.P. Reisenauer, Tetrahedron Lett. **25**, 5645 (1984).
31. K. Geibel, H. Mäder, Chem. Ber. **103**, 1645 (1970).
32. H.W. Lage, H.P. Reisenauer, G. Maier, Tetrahedron Lett. **23**, 3893 (1982).
33. In the IR spectrum three bands around 3400-3550, 1170-1300 (weak) and 790-950  $\text{cm}^{-1}$  should be found: a) J.M. Schulman, T.J. Venzani, J. Am. Chem. Soc. **96**, 4739 (1974). - b) B.A. Hess, L.J. Schaad, J. Am. Chem. Soc. **107**, 865 (1985).
34. L.B. Rodewald, H. Lee, J. Am. Chem. Soc. **95**, 623 (1973).
35. E. Hedaya, I.S. Krull, R.D. Miller, D.W. McNeill, P.F. D'Angelo, P. Schissel, J. Am. Chem. Soc. **91**, 1875 (1969). - E. Hedaya, R.D. Miller, M.E. Kent, P.F. D'Angelo, P. Schissel, J. Am. Chem. Soc. **91**, 6880 (1969).
36. Under our conditions we were unable to detect cyclobutadiene by pyrolysis of photo- $\alpha$ -pyrone. The only matrix isolated product was  $\alpha$ -pyrone.
37. W.E. Billups, L.-J. Lin, E.W. Casserly, J. Am. Chem. Soc. **106**, 3698 (1984).
38. S.W. Staley, T.D. Norden, J. Am. Chem. Soc. **106**, 3699 (1984).
39. A. Weber, M. Neuenschwander, Angew. Chem. **93**, 788 (1981); Angew. Chem., Int. Ed. Engl. **20**, 774 (1981).
40. Methylenecyclobutenone (60) - as we have checked in a control experiment - on irradiation also gives the IR bands of methylenecyclopropene as was claimed by Chapman without giving any details [O.L. Chapman, Pure Appl. Chem. **40**, 511 (1974)].
41. G. Maier, L.H. Franz, H.-G. Hartan, K. Lanz, H.P. Reisenauer, Chem. Ber., in print.
42. O.L. Chapman, C.L. McIntosh, Chem. Commun. **1971**, 770.
43. In more recent and independent studies Chapman and his group registered the same spectrum (personal communication).
44. G. Buemi, F. Zuccarello, A. Randino, THEOCHEM **1**, 137 (1981).
45. A. Schweig, W. Thiel, J. Comput. Chem. **1**, 129 (1980).
46. H.P. Reisenauer, G. Maier, A. Riemann, R.W. Hoffmann, Angew. Chem. **96**, 596 (1984); Angew. Chem., Int. Ed. Engl. **23**, 641 (1984); references cited therein.
47. a) D.N. Butler, I. Gupta, Can. J. Chem. **60**, 415 (1982). - b) A. Riemann, R.W. Hoffmann, J. Spanget-Larsen, R. Gleiter, Chem. Ber., in print.
48. T.J. Lee, A. Bunge, H.F. Schaefer III, J. Am. Chem. Soc. **107**, 137 (1985).
49. C.F. Kang, dissertation, Michigan State University 1972.
50. R.A. Bernheim, R.J. Kempf, J.U. Gramas, P.S. Skell, J. Chem. Phys. **43**, 196 (1965).