

Vitamin B₁₂-mediated electrochemical reactions in the synthesis of natural products

Rolf Scheffold, Stefan Abrecht, Ryszard Orlinski, Hans-Rudolf Ruf, Peristera Stamouli, Olivier Tinembart, Lorenz Walder and Christophe Weymuth

Institut für organische Chemie, Universität Bern, Freiestr.3, CH-3012 Bern

Abstract - Vitamin B₁₂ is an efficient catalyst in electroorganic synthesis since it acts as a mediator in the transfer of electrons from the cathode to electrophilic organic substrates. At the surface of the cathode B₁₂ is fast reduced to Co^I at an electrode potential, at which organic substrates remain electroinactive. Co^I reacts with electrophilic substrates R-Y as e.g. alkyl- and vinyl halides, α -halo ethers and acyl derivatives with formation of organocobalamins Co-R. As a result of further reduction, thermal or photochemical excitation, the Co-R bond is cleaved; R undergoes follow-up reactions *via* a radical- or carbanion pathway and the catalyst is recycled by reduction. Synthetically usefull B₁₂-catalyzed reactions are the reductive β -elimination and the conjugate addition of R-Y to activated olefins. The reductive β -elimination has been applied in the removal of β -halo ethyl protecting groups and the stereoselective synthesis of olefins like *trans*-5-decen-1-yl acetate and *trans*-10-propyl-trideca-5,9-dien-1-yl acetate. The B₁₂-catalyzed addition of R-Y to activated olefins has been applied in radical-type cyclisations and intermolecular additions of prim. and sec. alkyl-halides leading to: *trans*-9-oxo-2-decenoic acid ethylester, (1*R*,5*S*)-(+)-frontalin, (1*S*,5*R*)-(-)-frontalin, (1*R*,5*S*,7*S*)-(+)-*endo*-brevicomine, (1*R*,5*S*,7*R*)-(+)-*exo*-brevicomine as well as to (1*S*,2*R*,4*S*,5*R*)-(-)- α -, (1*S*,2*S*,4*R*,5*R*)-(-)- β -, (1*S*,2*R*,4*R*,5*R*)-(-)- γ - and (1*S*,2*S*,4*S*,5*R*)-(-)- δ -multistriatin. The C-glycosides, 3-(2,3,4,6-tetra-O-acetyl- α -D-glucosyl)propionitrile and 3-(2,3,5-tri-O-acetyl- β -D-ribofuranosyl)propionitrile are obtained from the 1-bromo-sugars and acrylonitrile. The conjugate addition of acid anhydrides to α,β -unsaturated aldehydes and ketones affords 1,4-dioxo compounds, the precursors of 2-cyclopentenones.

INTRODUCTION

Vitamin B₁₂ 1 (ref. 1) is a "pigment of life". It forms part of enzyme systems known to promote biochemical transformations (ref. 2) of no precedent in organic chemistry. Up to now only few applications of vitamin B₁₂ as catalyst of *in vitro* organic reactions are reported (ref. 3). Nevertheless we believe, that cobalamins and their derivatives will be of potential interest to the synthetic chemist for the following reasons:

- vitamin B₁₂ is a natural, nontoxic, chiral and enantiomerically pure catalyst,
- vitamin B₁₂ and related metal complexes are powerful mediators in electron-transfer reactions,
- according to Eschenmoser's most fascinating hypothesis on the prebiotic origin of porphyrin-type coenzymes (ref. 4) the cobalt corrins belong to the group of "first hour catalysts" taking part in the development of organic chemistry on earth,
- the accumulation of knowledge in B₁₂-chemistry may contribute to a deeper understanding of the (partially still unclear) mechanisms of coenzyme B₁₂-dependent biochemical transformations,
- the three acetamide and four propionamide side chains of B₁₂ offer a large potential for chemical modifications without touching the central cobalt corrin system (orientation of the side chains; axial- β : a and c, axial- α : b, d and e, equatorial: g and f),
- last but not least: vitamin B₁₂ is produced by industrial fermentation and is commercially available (ref. 5) (world market 1980 ca. 12'000 kg/year; bulk selling price ca. 3 to 20 US \$ per gram hydroxocobalamin hydrochloride 1a or cyanocobalamin 1b). Despite of the relatively high costs, vitamin B₁₂ and their derivatives might be applied as catalysts in organic synthesis, if the catalytic turnover is sufficiently high and if fine-chemicals are produced in selective reactions at clean conditions.

Several B₁₂-model compounds have been examined (refs. 3,6). The closest analogy to vitamin B₁₂ in structure and chemical reactivity show complexes of the [1-hydroxy-2,2,3,3,7,7,8,8,12,12,13,13,17,17,18,18-hexadecamethyl-10,20-diaza-octahydro-porphinato]cobalt(III)-dikation 3 (abbr. Co[HDP]²⁺) (refs. 7,8). Cheap and well-known B₁₂-models are the cobaloximes (refs. 9,10) and cobalt phthalocyanines (refs. 11, 12).

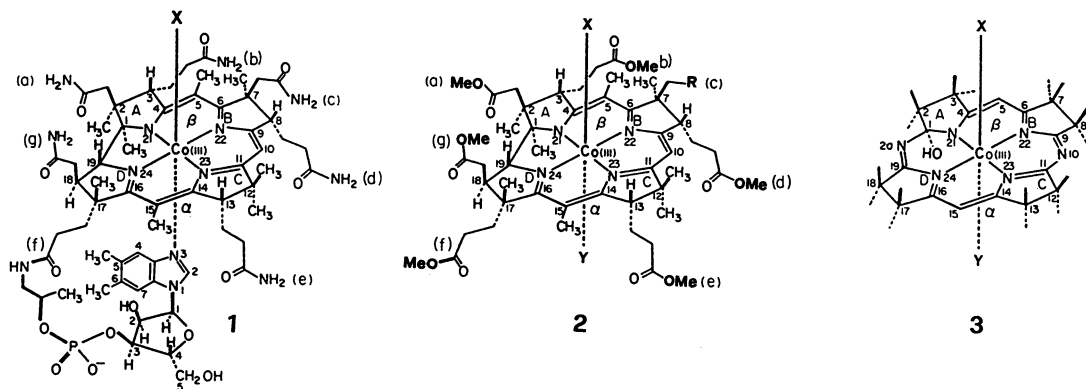

1a (X=OH·HCl) Hydroxocobalamin hydrochloride
mw. 1382.8

1b (X=CN) Cyanocobalamin
mw. 1355.4

1c (X=5'-deoxy-5'-adenosyl) Coenzyme B₁₂

sol. in H₂O, MeOH, DMF etc.
insol. in higher alcohols,
ethers, CH₂Cl₂ etc.

2 (R=COOMe, X=Y=CN) Heptamethyl-Co_α,Co_β-dicyanocobyrinat (Cobester)
mw. 1089.1
prep. from 1b by methanolysis (ref.13)

sol. in ethers, CH₂Cl₂,
higher alcohols etc.
insol. in H₂O, MeOH

3 (X=Y=Br) Dibromo[1-hydroxy-8H-HDP]cobalt(III)
mw. 778.6
prepared in five steps (ref. 7)
sol. in most organic solv.
insol. in H₂O

FUNDAMENTAL ASPECTS OF B₁₂ ELECTROCHEMISTRY

The electrochemistry of vitamin B₁₂ has been studied intensively by Savéant *et al.* (ref. 14). In vitamin B₁₂ (and related Co-complexes) generally Co^{III} is ligated by two axial ligands, Co^{II} by one and Co^I by none. This trend of decreasing coordination is qualitatively described by the X-Co-Y three center 4→5→6 electron bonding model with metal orbitals of substantial d_{z²}-character (ref. 15). The corrin macrocycle L represents by itself an electroactive subunit, which may undergo reduction.

The reduction potentials $E^{0'}_{III/II}$, $E^{0'}_{II/I}$ and $E^{0'}_{I/L}$ are dependent on the axial ligands X and Y, the solvent and the square planar macrocycle L. As metal reduction III→II→I is coupled with axial ligand expulsion, the corresponding reduction potentials strongly depend on the complex formation constant of ligands with Co in its different oxidation states. Complexes with strongly coordinating ligands require a more negative potential for reduction than complexes with weakly coordinating ligands. Scheme 1 shows a comparison of the redox potentials of hydroxocobalamin 1a and methylcobalamin 1 (X=CH₃). The values of $E^{0'}$ are represented by white zones separating the (dark) areas of thermodynamic stability of complexes at the indicated formal oxidation state of Co.

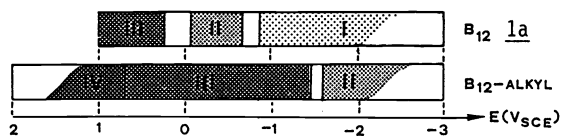

Scheme 1. Ranges of Stability at Different Oxidation State of Hydroxocobalamin (B₁₂ 1a) and Methylcobalamin (Alkyl = Me) separated by related Reduction Potentials (white zones).

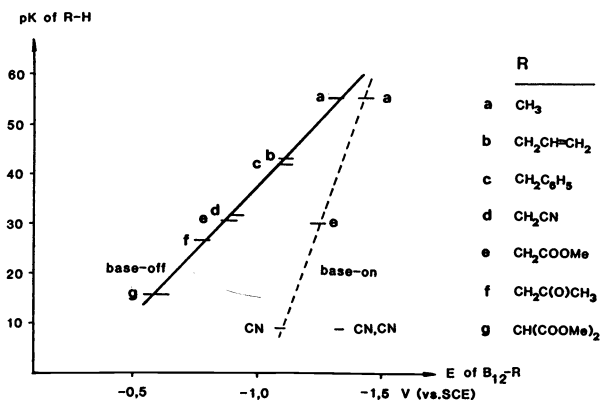

Scheme 2. Correlation between the Reduction Potential (III→II) of Organocobalamins B₁₂-R (in base-on and base-off Form) and the pK_a of R-H.

Recent work in our laboratory revealed a linear correlation between the first irreversible cathodic wave of organocobalamins B₁₂-R and the pK of R-H (Scheme 2) (ref. 16). In the cyclic voltammogram (high sweep rate) of some organocobalamins as e.g. B₁₂-CH₂-COOCH₃, a second (partially reversible) wave at much more

negative potential was observed; the current of the first wave decreases as the second one increases. These findings lead to the hypothesis, that the first (strongly pK-dependent) wave is due to the electron transfer to the base-off form of the organocobalamin and the second to the base-on form (Scheme 3).

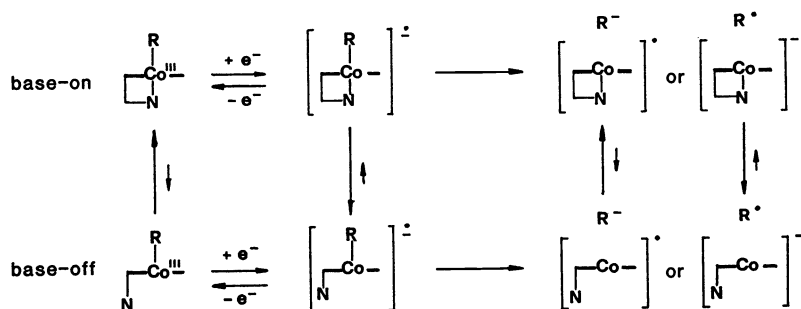

Scheme 3. Reductive Co-R bond Cleavage via base-on and base-off Form (N represents the benzimidazol ligand bound to side chain f).

The base-on and base-off forms are in equilibrium. If the negative electrode potential is built up slowly (slow sweep rate), the base-off form is reduced by an electron transfer into the axial system. The reduced species rapidly undergoes Co-R bond cleavage. On very high sweep rate however, the base-on form is reduced before dissociation of the benzimidazol-ligand takes place (very probably by an electron transfer into the lowest vacant π -orbital of the corrin). In view of reductive B₁₂-catalyzed reactions it is important to realize, that organo-B₁₂ intermediates containing an electron-withdrawing group at the ligating carbon atom are easily reduced via the base-off form. Their reduction potential is positive enough to be reduced by Co^I (ca. -0.9 V) to form enolates which may be trapped by proton-transfer.

VITAMIN B₁₂-CATALYZED C,C-BOND FORMATION

Some years ago it has been found in our laboratory, that vitamin B₁₂ 1a and related Co-complexes as e.g. 3 efficiently catalyze the reductive, conjugate addition of alkylhalides to activated olefins (refs. 17,18) according to equation 1:

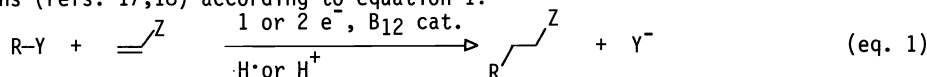

R-Y = Alkyl-, Vinylhalide, α -haloether, acyl derivatives
Z = Electron-withdrawing group

In the meantime much information and some new insights have been accumulated. The dissociation energy of the Co,C-Bond in organocobalamins strongly depends on the size of the group R bound to Co. Primary alkylcobalamins are stable at room temperature (the dissociation energy is in the range of 20-30 kcal/mol (ref. 19)). Sec. and tert. alkylcobalamins however decompose rapidly. In B₁₂-models like cobaloximes and 3 organocobalt-derivatives with sec. alkyl groups have been crystallized and their structure has been determined by X-ray analysis (refs. 20,21). The apparent stability of organocobalt complexes can be rationalized by reversible bond-fission and bond-formation a process often invoked for B₁₂-coenzyme dependent biochemical reactions (ref. 22). Radical scavengers as e.g. Sn^{III} or Au^{II} species as well as Co^{II} effect transalkylation (refs. 23,24). The decreasing stability of organocobalamins with growing size of the alkyl group has been attributed to a distortion of the Co,C-bond (ref. 25). With regard to the large difference in stability of organocobalamins in which Co is formally bound to prim. alkyl-, sec. alkyl- or acyl groups, it is not surprising, that the reaction-pathway in the reductive conjugate addition of R-Y to (activated) olefins strongly depends on the structure of R. Different pathways of the C,C-bond forming reaction (eq. 1) are outlined in scheme 4.

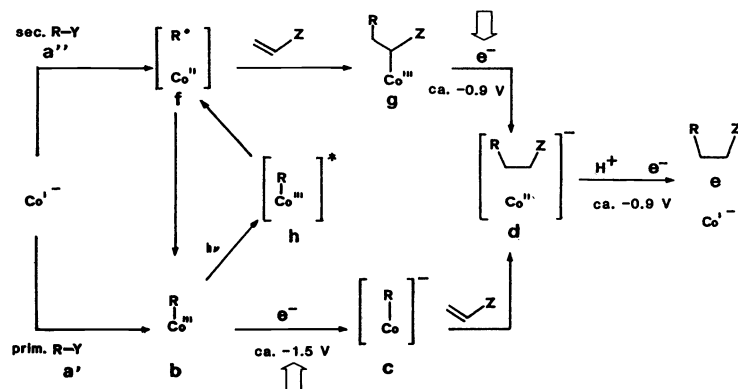

Scheme 4. Reaction Scheme for the B₁₂-Catalyzed Reductive, Conjugate Addition of prim. a' and sec. a'' Alkylhalides to Activated Olefins

Experimental facts

Prim. alkylhalides (and vinylhalides) react with activated olefins in presence of catalytic amounts of **1a** (0.1 to 5 mol% with respect to R-Y = 100 mol%) in the dark at potentials more negative than ca. -1.5 V (vs. SCE). In this text the abbreviation B₁₂/EC is used for B₁₂-electro catalysis.

Sec. alkylhalides (as well as allylhalides and α -halo ethers) react in the dark already at potentials more negative than ca. -0.9 V (abbr. B₁₂/EC) or in presence of metallic Zn and NH₄Cl as reducing agent (abbr. B₁₂/Zn).

Prim. alkylhalides and acid anhydrides react in presence of visible light (400 to 600 nm) already at potentials more negative than ca. -0.9 V (abbr. B₁₂/PEC for B₁₂-photo electro catalysis).

Mechanistic interpretation (Scheme 4)

Reaction with prim. alkylhalides **a'** in the dark:

Co^I (generated at ca. -0.9 V) and the alkylhalide **a'** undergo oxydative addition to form **b**. At potentials more positive than ca. -1.4 V and in the dark, the alkylcobalamin **b** remains unchanged. On lowering the potential to values more negative than ca. -1.5 V, **b** is reduced via the short lived "one-electron intermediate" **c**, which immediately decomposes. In presence of an activated olefin, the group R is transferred to its β -carbon to give **d**. Protonation and reduction of Co^{II} (or alternatively H⁺-transfer to **d**) affords the product **e** and recycled Co^I.

Reaction with sec. alkylhalides **a''** in the dark:

Co^I and **a''** react (most probably in a multistep reaction via electron transfer) with formation of a radicalpair-type organocobalamin **f**. If a radical scavenger, here the activated olefin, approaches the intermediate **f**, R' is transferred to the β -carbon of the olefin with formation of the intermediate **g** (compounds of type **g** with R=CH₃ and Z=COOCH₃ etc. have been isolated). According to values recorded in scheme 2, type **g** organocobalamins are reduced (in their base-off form) already at ca. -0.9 V with formation of the intermediate **d**. Again protonation and reduction affords **e** and recycled Co^I. In sharp contrast to prim. alkylhalides, the reaction of sec. alkylhalides already proceeds at potentials of ca. -0.9 V. Stereochemical information located at the sec. carbon atom will be lost during the reaction.

Reaction with prim. alkylhalides **a'** in presence of visible light:

Oxydative addition of Co^I to **a'** affords **b**. On irradiation of visible light (minimum energy ca. 600 nm) **f** is produced via the excited state **h** (the photochemical activation is formally a vertical redox reaction since a π -electron of the corrin is transferred into the axial system). If **f** is not quenched efficiently, it will deactivate to **b** (refs. 26,27). In presence of activated olefins however, the radical transfer of R' is a concurring reaction to give **g**. Formation of final products see above.

Reaction with acyl derivatives (R=R'CO) in presence of visible light:

The B₁₂/PEC reaction using acetic anhydride as acylating reagent has been studied in detail (ref. 28). Acylcobalamins **b** (R=R'CO) are formed in the reaction of Co^I with acylating agents. In absence of light acylcobalamins are stable. Photolysis of **b** takes place efficiently only in presence of activated olefin. The rate constant of acetylation of Co^I by acetic anhydride ($k=0.017 \text{ M}^{-1}\text{s}^{-1}$), the quantum yield of visible light induced cleavage of **b** ($\phi=0.35$) and the relative rates $k(\text{rel.})$ of acylation of a series of activated olefins has been determined from catalytic currents. The log k -values of the acetyl transfer reaction correlate well with the reduction potential of the activated olefin (Scheme 5). Using σ_p^- -values of olefins (instead of their reduction potential) three linear free-energy relationships [for olefins bearing two, one or none substituent at C(β)] are observed with $\rho=2.3$, a typical value for the attack of a nucleophilic radical to an activated olefin (ref. 29).

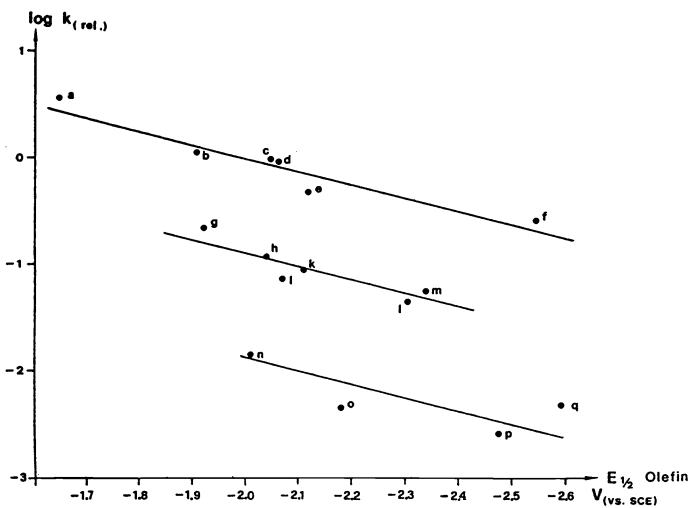

Scheme 5. Correlation between Relative Reaction Rates and the Reduction Potential of Olefins in the B₁₂/PEC Reaction with Acetic Anhydride.

- a) acrolein, b) methyl vinyl ketone, c) acrylonitrile, d) ethyl acrylate, e) 2-methyl ethyl acrylate, f) acrylamide, g) croton aldehyde, h) 2-methyl-croton aldehyde, i) cyclohexanone, k) cyclopentanone, l) crotonitrile, m) ethyl crotonate, n) 3-methyl-2-butenal, o) 2-methyl-4-oxo-2-butene, p) 3-methyl ethyl crotonate, q) 3-methyl crotonitrile.

VITAMIN B₁₂-CATALYZED REDUCTIVE ELIMINATION

Vitamin B₁₂ 1a and related Co-complexes as e.g. 3 are efficient catalysts in the reductive elimination of *vicinal* leaving groups according to equation 2:

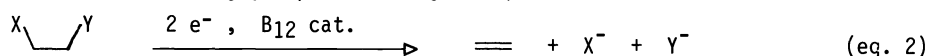

X and Y = Leaving Groups

The reaction proceeds at very mild conditions (at an electrode potential of ca. -1.5 V or with metallic Zn and NH₄Cl in presence of catalytic amounts (ca. 0.1 to 5 mol%) 1a, 2 or other Co-complexes as e.g. 3).

Experimental facts

In a mechanistic study on the stereochemistry of the B₁₂-catalyzed reductive elimination it has been found, that *threo*- and *erythro*-3-bromo-2-butanol affords mixtures of *cis*- and *trans*-2-butene (refs. 3, 30) (Table 1).

Table 1. Reductive Elimination of *threo*- and *erythro*- 3-bromo-2-butanol with Zn/NH₄Cl

B ₁₂ <u>1a</u> in mol %	Solvent	T ^{a)} °C	<i>threo</i> -		<i>erythro</i> -	
			<i>cis</i> :	<i>trans</i>	<i>cis</i> :	<i>trans</i>
1.4	EtOH/H ₂ O	20	1 :	99	45 :	55
1.4	DMSO	20	3 :	97	98 :	2
1.4	DMF	20	18 :	72	96 :	4
no	EtOH/H ₂ O	60	54 :	46	0 :	100 ^{b)}

a) Reaction Time 18 h b) contaminated by 6% non-olefinic compound

It follows from the results listed in table 1, that the B₁₂-catalyzed elimination (in solvents like DMF, DMSO etc.) proceeds preferentially as *syn*-elimination. The same results have been observed in the elimination of *vicinal* dibromides (ref. 30), *vicinal* dichlorides (ref. 30) and 1-halo-2-alkoxy derivatives (refs. 3, 30, 31).

Mechanistic interpretation (Scheme 6)

It is interesting to note that the B₁₂-catalyzed reductions in DMSO yield almost pure *trans*-2-butene from the *threo*-bromohydrin and almost pure *cis*-2-butene from the *erythro*-bromohydrin (Table 1). This is probably due to the ability of the solvent to promote S_N2-reactions. We therefore favour a mechanism for the B₁₂-catalyzed reaction in DMSO, which consists in a Co,C-bond formation with inversion of configuration at carbon followed by a fast reductive decomposition of the intermediate organocobalamin in an *anti*-elimination (ref. 3). The over-all result corresponds to a reductive *syn*-elimination. Until now the postulated intermediate has not been isolated, therefore the proposed mechanism remains hypothetical. It is of interest, that Angst comes to similar conclusions in the reductive eliminations catalyzed by cobester 2/Zn NH₄Cl in THF as solvent (ref. 31).

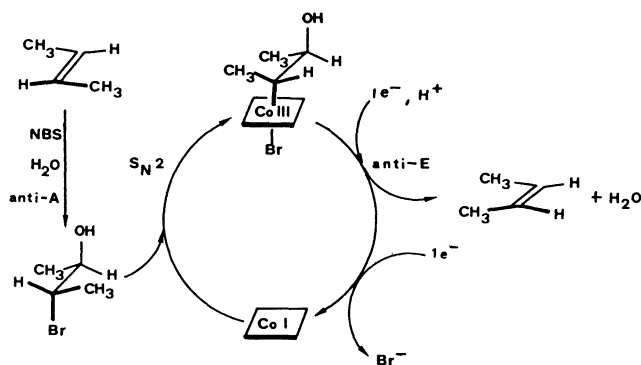

Scheme 6. Proposed Mechanism for the Vitamin B₁₂-catalyzed reductive elimination of *vicinal* leaving groups.

If vitamin B₁₂-catalyzed reactions (C,C-bond formations and eliminations) are carried out in protic solvent, the hydrogenolysis of R-Y to R-H might occur as a side reaction. This hydrogenolysis might become a main reaction, if the organocobalt intermediate is fast reduced at a very negative potential (at the carbon electrode) and if the scavenger concentration is low.

VITAMIN B₁₂ IN NATURAL PRODUCT SYNTHESIS

The application of vitamin B₁₂ and related compounds as catalysts in organic synthesis has been reviewed 1983 (ref. 3). Until now there exist only few reports on B₁₂-catalyzed reactions directed to organic synthesis. In a series of publications Fischli *et al.* report on the reduction of functional groups (ref. 32), enantioselective hydrogenation of α,β -unsaturated carbonyl derivatives (ref. 33) and C,C-rearrangements (ref. 34) using B₁₂/Zn/CH₃COOH. Very recently **2** has been applied as catalyst in the synthesis of β,γ -unsaturated amino acids by reductive ring opening of chloromethyl oxazolines (ref. 31). We are studying the chemistry of vitamin B₁₂ and B₁₂-derivatives with regard to applications in electrochemical processes.

Electroorganic synthesis is not a mystery

Many chemists, interested in organic synthesis, will never deal with electrosynthesis because some other hardware than round bottom flasks are needed. In fact, for small-scale synthesis exceedingly simple equipment is used (cf. Baizer's classical textbook, ref. 35). In this study different types of divided H-type cells and Sandwich cells (ref. 36) were used. The working electrode (cathode) is carbon-felt (non-toxic, cheap, large surface). As cell divider a glass frit or Nafion foil is used. The electrolyte is in most cases 0.2 M LiClO₄ in DMF or H₂O/EtOH. The electrolyses are performed at constant potential.

Syntheses *via* reductive eliminations

Protecting group chemistry:

The β -chloro- and β -bromo ethyl group (and analogues) attached to electronegative atoms are easily removed by B₁₂-catalyzed reductive elimination (Table 2).

Table 2. Reductive cleavage of β -haloethyl protecting groups

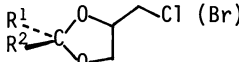
Entry	Functional group	Protected functional group	Method ^{a)} and conditions of deprotection	Yield % (isol.)	Ref.
1	Carboxylic acid	R-COO-CH ₂ -CH ₂ -Cl (Br)	B ₁₂ /Zn r.t. 5 - 30 h B ₁₂ /EC 0 ^o ca. 10 h	> 90 > 90	3,30,37 3,30,37
2	Aldehydes and Ketones ^{b)}	 R ¹ R ² -C(CH ₂ -CH ₂ -Cl)O	B ₁₂ /Zn r.t. 5 - 30 h	> 90	3,30
3	Alcohols, Phenols Enols	R-O-COO-CH ₂ -CH ₂ -Cl (Br)	B ₁₂ /Zn r.t. 5 - 30 h	> 90	3,30
4	Amines	R ¹ R ² N-COO-CH ₂ -CH ₂ -Cl(Br)	B ₁₂ /Zn r.t. 5 - 30 h	> 90	3,30,37

a) B₁₂/Zn : 1 mol % **1a**, excess Zn-powder (activated by washing with 1 N HCl, EtOH, drying), NH₄Cl, MeOH (or other protic solvent), stirring under N₂.

B₁₂/EC : Constant potential electrolysis at Hg-pool or carbon-felt electrode at -1.7 V, 0.2N LiClO₄/ MeOH or DMF in presence of 1-5 mol % **1a**, NH₄Cl (buffer) under N₂

b) Protection: Carbonyl compound in α -epichlorohydrin in presence of Et₄NBr heating at rf. for ca. 5 hs., then evaporation of excess α -epichlorohydrin and dist.

Olefin synthesis:

The B₁₂-catalyzed reductive *syn*-elimination of vicinal leaving groups has been applied in the synthesis of olefins (ref. 3, 30, 37). A reaction sequence, originally developed by Boord (ref. 38), allows the synthesis of olefins from enolethers *via* 1) addition of X₂ (Br₂) to the olefin (*anti*-A), 2) substitution of the α -halogen by a Grignard reagent (S_N2), 3) reductive elimination of X⁻ and RO⁻ (*syn*-E). An example is the synthesis of *trans*-5-decen-1-yl acetate (Scheme 7). This pheromone of the peach borer moth *Anarsia Lineatella* (ref. 39) was obtained in four steps (over-all yield 70%, *trans*-selectivity >93%) from 1-bromo butane and the

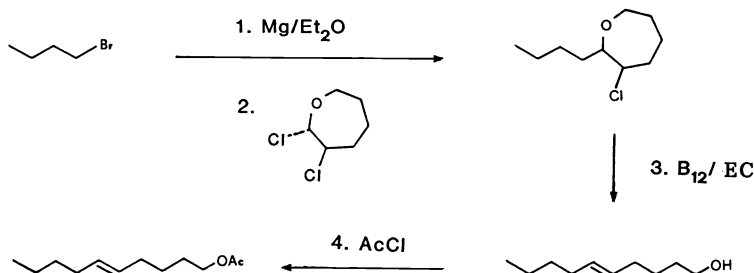

Scheme 7. Synthesis of *trans*-5-decen-1-yl acetate. (B₁₂/EC at -1.6 V, in 0.2 N LiClO₄/DMF in presence of 2 mol % **1a** at r.t. under N₂)

2,3-dichloro-oxepan (prepared by chlorination of oxepan with SO₂Cl₂, 1 h 40⁰ in 68%). Likewise *trans*-10-propyl-trideca-5,9-dien-1-yl acetate (*Propylure*) (ref. 40) was prepared with the Grignard-reagent, made from 1-bromo-4-propyl-3-heptene (ref. 3, 30).

Synthesis via C,C-bond formation

The vitamin B₁₂-catalyzed C,C-bondforming reaction is a welcomed addition to the tool of synthetic methods. It may easily be carried out in milligram to multigram scale at mild and non-toxic conditions (review ref. 41).

Cyclisations by intramolecular B₁₂-catalyzed addition:

The B₁₂-catalyzed cyclisation by electrolysis at -1.4 to -1.6V in presence of ca. 5 mol% **1a** or **3** of α,β -unsaturated ketones bearing a ω -bromo side chain occurs in excellent yields in case of 5-exo-trig or 6-endo-trig arrangement (Scheme 8), (ref. 17).

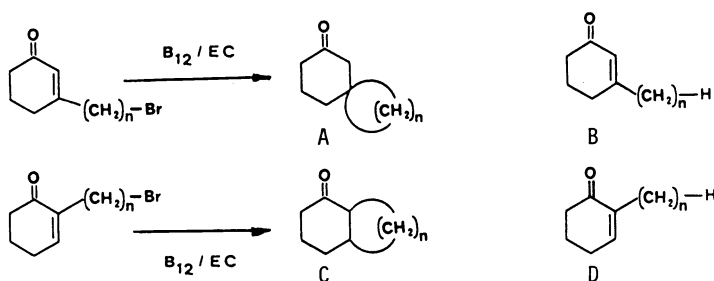

Scheme 8. Cyclisations under B₁₂/EC-conditions

n	Yield (% isol.)	
	A	B
3	-	90
4	95	-
5	45	40
n	C	D
3	-	90
4	95	-
5	70	10

Likewise 6-bromoalkines cyclise under B₁₂/Zn-conditions in 5-exo-dig fashion to afford the precursors of α - and β -methylene lactones (Scheme 9), (ref. 43). Similar cyclisations occur with tin organic reagents (ref. 42) and cobaloximes (refs. 44 - 46).

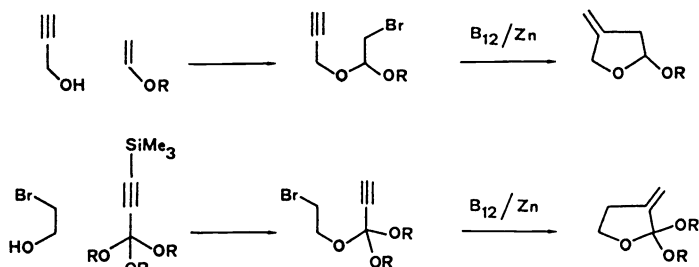

Scheme 9. Cyclisations under B₁₂/Zn-conditions (in DMF) Synthesis of Methylene-cyclopentan Derivatives.

Intermolecular B₁₂-catalyzed additions:

The consecutive addition of R-Y to activated olefins by electrolysis in presence of **1a** (B₁₂/Zn, B₁₂/EC or B₁₂/PEC-conditions, depending on the structure of R-Y) allows the construction of extended carbon chains as shown in the synthesis of ethylester of *trans*-9-oxo-2-decenoic acid (Scheme 10), (ref. 47), (for earlier synthesis of "Queen substance" of *Apis mellifera* cf. ref 48).

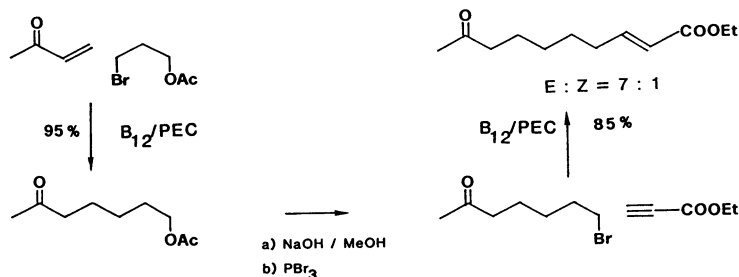

Scheme 10. Synthesis of the ethylester of "Queen Substance" by two consecutive B₁₂/PEC steps.

The exceedingly mild conditions of the B₁₂/PEC reaction (-0.9 V) are suited for the addition of prim. alkylhalides containing a potential leaving group in β -position. Examples are the syntheses of *endo*- and *exo*-brevicomins in opt. active form (Scheme 11), (ref. 49), (for earlier synthesis of these bark-beetle pheromons cf. 50). Scheme 11 reports two remarkable steps: the highly selective transformation of the sec. alcohols into the prim. iodides by methyltriphenoxyposphonium iodide (ref. 51) and the very efficient B₁₂/PEC-steps.

Likewise (*1R,5S*)-(+)- and (*1S,5R*)-(-)-frontalin have been prepared in excellent purity and yield by B₁₂/PEC-reaction of methyl vinyl ketone with the corresponding halides (ref. 52). The two R-Y components, (*R*)-2,2-dimethyl-4-iodomethyl-4-methyl-1,3-dioxolane and (*S*)-4-bromomethyl-4-methyl-2-oxo-1,3-dioxolane were made in "classical" steps from β -methallyl alcohol via Sharpless oxydation using *L*(+)-diisopropyltartrate. For earlier syntheses of racemic and opt. active frontalin cf. ref. 50.

For the synthesis of the biologically active elm bark beetle pheromons, the multistriatins with (1*S*,5*R*)-configuration (Scheme 12), the same starting materials as for the brevicomins (Scheme 11) have been used. The conversion of the sec.alcohols into the sec.iodides with inversion of configuration has been achieved with methyl-dicyclohexyl-carbodiimidium iodide MDCCI (ref. 53). As explained above, the B₁₂-catalyzed C,C-bond formation of these sec.iodides with 2-methyl-3-oxo-1-pentene proceeds already at -0.9 V in the dark (B₁₂/EC or B₁₂/Zn) and affords a mixture of diastereomers. After acid-catalyzed cyclisation the enantiomerically pure α-, β-, γ- and σ-multistriatins with (1,5*R*)-configuration were separated by GLC (ref. 54).

Scheme 11. Synthesis of Brevicomins

Scheme 12. Synthesis of Multistriatins

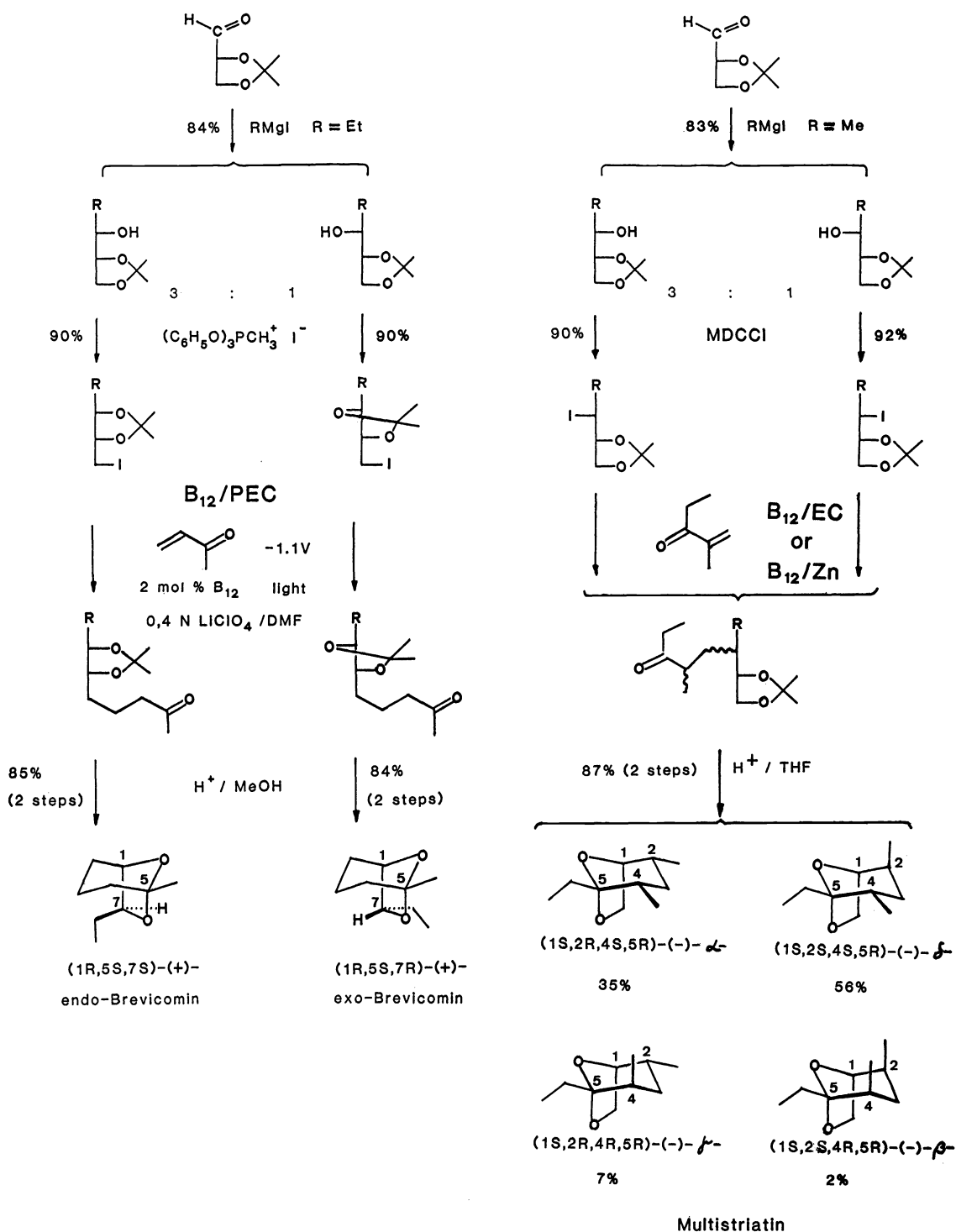

The synthesis of C-glycosides may be achieved by B₁₂-catalyzed C,C-bond formation. An example is the preparation of 3-(2,3,4,6-tetra-O-acetyl- α -D-glucosyl)propionitrile (Scheme 13, above) from acetobromo glucose by reduction with Zn/NH₄Cl in DMF in presence of acrylonitrile and 3 mol % **1a** (ref. 55). The same compound was synthesized by Giese (ref.56) using alkyltin-compounds as catalysts for the generation of radicals. Interestingly the B₁₂-catalyzed C,C-bond formation can also be applied for the synthesis of the corresponding ribofuranosyl derivatives (ref. 43),(Scheme 13, below).

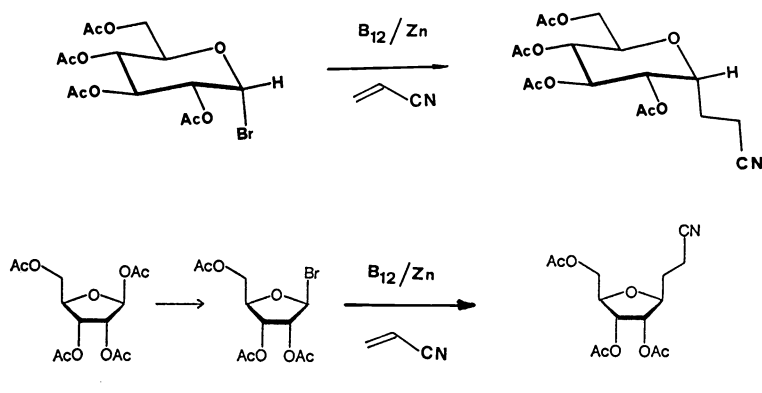

Scheme 13. Synthesis of 3-(2,3,4,6-tetra-O-acetyl- α -D-glucosyl)propionitrile

Synthesis of 3-(2,3,5-tri-O-acetyl- β -D-ribofuranosyl)propionitrile (the very delicate bromide was prepared from the acetate with trimethylsilylbromide, the coupling reaction was achieved with **3** as catalyst in acetonitrile as solvent).

A useful extension of the B₁₂-catalyzed formation of C,C-bonds is the "nucleophilic acylation" by acid anhydrides (and other acyl derivatives). Acid anhydrides react under B₁₂/PEC-conditions (electrolysis at ca. -0.9V in 0.2N LiClO₄/DMF, ca. 2 mol % **1a** under irradiation of visible light) with α,β -unsaturated carbonyl compounds and other activated olefins to give the corresponding 1,4-addition products (ref. 57). An example is outlined in scheme 14.

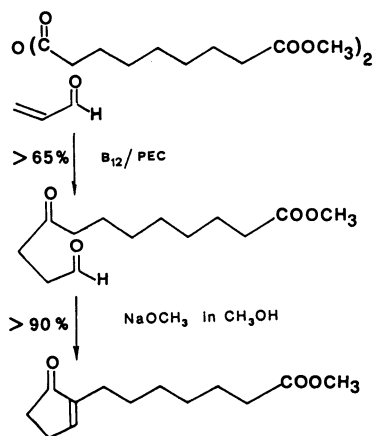

Scheme 14. Synthesis of a 1,4-dioxo derivative by B₁₂-catalyzed photo electro catalysis (B₁₂/PEC). This reaction is a useful extension of the known "nucleophilic acylation methodologies" as e.g. the Stetter-reaction (ref. 58), since α,β -unsaturated aldehydes react perfectly and since functional groups (like carbonyl, ester, amid etc.) are tolerated in both starting components.

CONCLUSION AND OUTLOOK

Vitamin B₁₂ is a useful catalyst in organic synthesis and electrosynthesis. It creates radical type intermediates under exceedingly mild and non-toxic reaction conditions. Enantioselective catalysis seems to be possible, first results in hydrogenation of activated olefins (ref. 33) and C,C-bond formation (ref. 59) are promising. Another field of new development is the modification of electrode surfaces by immobilized B₁₂-derivatives (ref. 60) designed for applications in electrosynthesis and as sensors.

Acknowledgement

This work was financially supported by the *Schweizerischer Nationalfonds zur Förderung der wissenschaftlichen Forschung*.

REFERENCES

1. D. Dolphin (Ed.), "B₁₂", Vol.1:"Chemistry", Vol.2,"Biochemistry and Medicine", J. Wiley New York, 1982.
2. J. Rétey, J. A. Robinson, "Stereospecificity in Organic Chemistry and Enzymology", Verlag Chemie, Weinheim, 1982, pp.185-207.

3. R. Scheffold, G. Rytz, L. Walder, "Modern Synthetic Methods" R. Scheffold (Ed.), Vol.3: Salle, Frankfurt / Sauerländer, Aarau / J.Wiley, London, 1983, pp. 355-440.
4. A. Eschenmoser, *Nova Acta Leopoldina*, 55, 5 (1982).
5. G. Barrère, B. Geneste, A. Sabatier, *Pour la Science*, Nr. 49, 56 (1981).
6. D. Dodd, M.D. Johnson, *J.Organomet.Chem.* 52, 1-232 (1973).
7. G. Rytz, R. Scheffold, *Helv.Chim.Acta*, 63, 733 (1980).
8. L. Walder, G. Rytz, U. Vögel, R. Scheffold, P. Engel, *Helv.Chim.Acta*, 67, 1801 (1984).
9. G. N. Schrauzer, *Inorg.Synth.* 11, 61 (1968).
10. G. N. Schrauzer, *Angew.Chem.* 88, 465 (1976); *Int. Ed. Engl.* 15, 417 (1976).
11. H. Eckert, Y. Kiesel, *Angew.Chem.* 93, 477 (1981); *Int. Ed. Engl.* 20, 473, (1981).
12. J.H. Weber, D.H. Busch, *Inorg. Chem.* 4, 469 (1965).
13. L. Werthemann, Ph.D. Thesis ETH-Zürich, No. 4097, 1968.
14. D. Faure, D. Lexa, J.M. Savéant, *J.Electroanal.Chem.* 140, 285, 297 (1982) and earlier publ.
15. J.F. Endicott, J. Lilie, J.M. Kuszaj, B.S. Ramaswami, W.G. Shamonses, M.G. Simic, M.D. Glick D.P. Rillema, *J.Am.Chem.Soc.* 99, 429 (1977).
16. O. Tinembart, unpubl. results, part of the Thesis, Univ. Bern (in preparation).
17. R. Scheffold, M. Dike, S. Dike, T. Herold, L. Walder, *J.Am.Chem.Soc.* 102, 3642 (1980).
18. R. Scheffold, *Chimia*, 39, 203 (1985).
19. J. Halpern, Sook-Hui Kim, T.W. Leung, *J.Am.Chem.Soc.* 106, 8317 (1984).
20. Ch. Bosshard, Ph.D. Thesis, Univ. Bern 1982.
21. L. Randaccio, N. Bresciani, P.J. Toscano, I.G. Marzilli, *J.Am.Chem.Soc.* 103, 6347 (1981).
22. R.H. Abeles, D. Dolphin, *Acc.Chem.Res.* 9, 114 (1976).
23. L.J. Dizikes, W.P. Ridley, J.M. Wood, *J.Am.Chem.Soc.* 100, 1010 (1978).
24. D. Dodd, M.D. Johnson, B.L. Lockman, *J.Am.Chem.Soc.* 99, 3664 (1977).
25. D.W. Christianson, W.N. Lipscomb, *J.Am.Chem.Soc.* 107, 2682 (1985).
26. B. Kräutler, *Helv.Chim.Acta*, 67, 1053 (1984).
27. H. Fischer, *J.Am.Chem.Soc.* 108, 3925 (1986).
28. L. Walder, J. Orlinski, *Organometallics*, in print.
29. A. Citterio, A. Arnoldi, F. Minisci, *J.Org.Chem.* 44, 2674 (1979).
30. M. Philippe, Ph.D. Thesis, Univ. Bern 1983.
31. Ch. Angst, *Pure Appl.Chem.* (this volume)
32. A. Fischli, *Helv.Chim.Acta*, 61, 2560 (1978).
33. A. Fischli, D. Süss, *Helv.Chim.Acta*, 48, 2361 (1979).
34. T.S. Wan, A. Fischli, *Helv.Chim.Acta*, 67, 1883 (1984).
35. M.M. Baizer (Ed.), "Organic Electrochemistry", Dekker, New York, 1973.
36. B. Steiger, L. Walder, R. Scheffold, *Chimia*, 40, 93 (1986).
37. R. Scheffold, E. Amble, *Angew.Chem.* 92, 643, (1980); *Int.Ed.Engl.* 19, 629 (1980).
38. M. Schlosser, in Houben-Weyl: "Methoden der org.Chemie", 4th Ed., Vol. V/1b, 212 (1972).
39. W. Roelofs, J. Kochansky, E. Anthon, R. Rice, R. Carde, *Environ.Entomol.* 4, 580 (1975).
40. H.E. Hummel, R.M. Silverstein, *Science*, 181, 873 (1973).
41. R. Scheffold, *Chimia*, 39, 203 (1985).
42. G. Stork, in W. Bartmann, B.M. Trost: "Selectivity-a Goal for Synthetic Efficiency", Verlag Chemie, Weinheim 1984, pp. 281-298.
43. S. Abrecht, Ph.D. Thesis, Univ. Bern 1986.
44. M. Okabe, M. Tada, *J.Org.Chem.* 47, 5382 (1982).
45. S. Torii, T. Inokuchi, T. Yukawa, *J.Org.Chem.* 50, 5875 (1985).
46. H. Bhandal, G. Pattenden, J.J. Russell, *Tetrahedron Lett.* 27, 2299 (1986).
47. R. Orlinski, unpubl. results.
48. T.A. Hase, K. McCoy, *Synth.Commun.* 9, 63 (1979) and lit. cited therein.
49. H.-R. Ruf, unpubl. results. Part of the Ph.D. Thesis, Univ. Bern (in preparation).
50. K. Mori, in J. ApSimon: "The Total Synthesis of Natural Products", J. Wiley, N.Y., 4, 1 (1981).
51. R. Dumont, H.-P. Pfander, *Helv.Chim.Acta*, 66, 814 (1983).
52. R. Orlinsky, R. Scheffold, *Helv.Chim.Acta*, (in preparation).
53. R. Scheffold, E. Saladin, *Angew.Chem.* 84, 158 (1972); *Int.Ed.Engl.* 11, 229 (1972).
54. P. Stamouli, unpubl. results, part of the Ph.D. Thesis, Univ. Bern (in preparation).
55. S. Abrecht, R. Scheffold, *Chimia*, 39, 211 (1985).
56. B. Giese, J. Dupuis, *Angew.Chem.* 95, 633 (1983); *Int.Ed.Engl.* 22, 622 (1983).
57. R. Scheffold, R. Orlinski, *J.Am.Chem.Soc.* 105, 7200 (1983).
58. H. Stetter, *Angew.Chem.* 88, 695 (1976); *Int.Ed.Engl.* 15, 639 (1976).
59. B. Steiger, unpubl. results.
60. A. Ruhe, L. Walder, R. Scheffold, *Helv.Chim.Acta*, 68, 1301 (1985).