

Some chemistry of hindered organoboranes

Andrew Pelter

University College of Swansea, Swansea, SA2 9PP, U.K.

Abstract. Boron stabilised carbanions can be made through the use of highly hindered diarylboranes. Some reactions of the anions so produced are discussed. A spin-off of this work is the production of some stable mono and diarylboranes which hold great promise as reagents of general application. In a similar fashion, highly hindered and very stable alkyldiarylhydroborates are now available for selective reductions.

I entered the field of hindered diarylorganoboranes due to my interest in extending the chemistry of organoboranes to the chemistry of boron stabilised carbanions. In Table 1 are shown the results of calculations of the stabilisation energies of alkyl [1,2] and alkenyl carbanions [3] adjacent to first row elements. In each case the stabilisation peaks at boron. The stabilisation by a carbonyl group is calculated [2] to be comparable to the stabilisation by an isoelectronic boron atom, and on this basis boron stabilised carbanions should be intermediates of synthetic significance in organic chemistry.

Table 1

| X | BeH | BH ₂ | CH ₃ | NH ₂ | OH | F |
|--|------|-----------------|-----------------|-----------------|-----|------|
| S.E. for X-CH ₂ ⁽⁻⁾ | -133 | -229 | +24 | +8 | -32 | -65 |
| S.E. for CH ₂ =C-X ⁽⁻⁾ | -99 | -175 | +5 | -27 | -80 | -108 |

I decided to use the base induced α -deprotonation of organoboranes to produce the required carbanions. This meant that the formation of organoborates had to be discouraged either electronically or sterically (or both) and in order to take advantage of the rich chemistry of organoboranes a steric hindrance approach was first adopted [4]. Initial experiments soon showed that both the organoboranes and the bases had to be highly hindered if success were to be achieved, and we therefore developed the reagents and methodology shown in Figure 1. With minor modifications the methodology shown for the dimesitylboryl series applies to both the other sets of compounds.

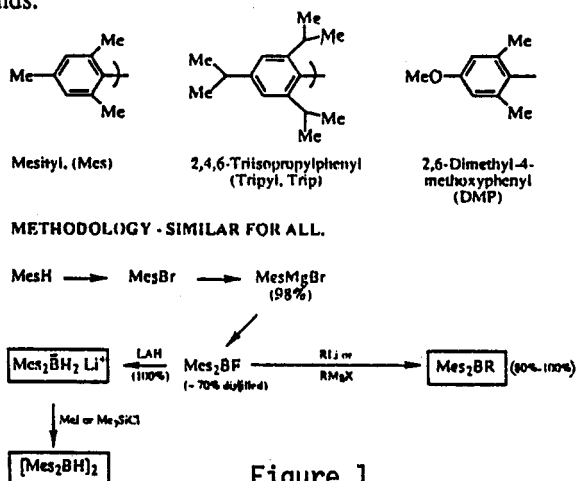

Figure 1

The reactions of bases with alkyl-dimesitylboranes were then investigated, and a typical study is shown in Figure 2. In practise mesityllithium is our base of choice as it is more generally applicable than lithium dicyclohexylamide and gives only an innocuous hydrocarbon as side product. Mesityllithium is readily available and is of general application as a very hindered base without β -hydrogen atoms.

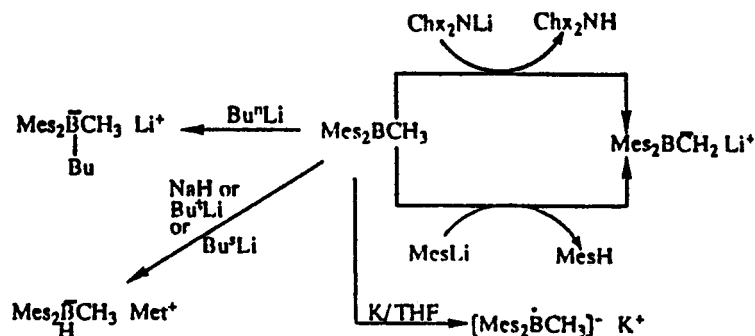

Figure 2

With boron stabilised carbanions readily available, it was now possible to study their physical and chemical properties. An X-ray study [5] of $\text{Mes}_2\text{BCH}_2\text{Li}$ showed a shortening of the C-B bond to that approximating to the length calculated for a C=B, whilst n.m.r. studies showed that the rotational barrier around the C-B bond of the anions approximates to that of the isoelectronic B-N bond [6].

The chemical studies were initiated with a study of the alkylation of dimesitylboryl stabilised carbanions, the results of which are shown in Figure 3 [4].

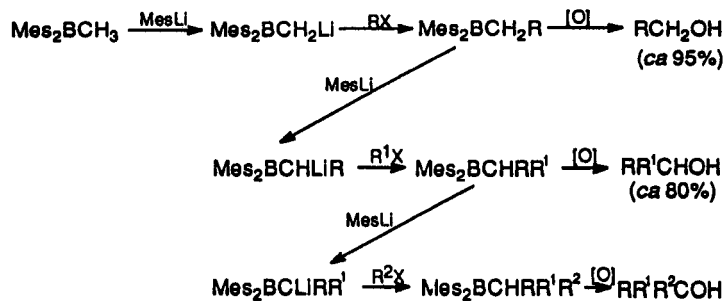
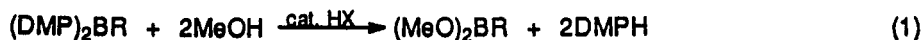

Figure 3

These reactions provide general syntheses of primary and secondary alcohols in good yields. However, although the production of *tert*-alkyl-dimesitylboranes was surprisingly easy, the release of the *tert*-alkyl group by oxidation became very difficult, even under forcing conditions. For this reason we developed the $(\text{DMP})_2\text{BR}$ series in which electrophilic attack is switched from the extremely hindered boron atom to the aromatic group, as shown in equation 1 [7].



This solvolysis is an extremely easy process, and consequently the DMP group provides a link between the highly hindered boranes and dialkoxyboranes from which boron stabilised carbanions cannot be made [8]. The product alkyl-dimethoxyborane can then, of course, be readily oxidised to the corresponding alcohol or otherwise manipulated.

The reactions of $\text{Mes}_2\text{BCH}_2\text{Li}$ with metal halides provides a series of metallated dimesityl-borylmethanes (Figure 4), each with a rich chemistry of its own [9]

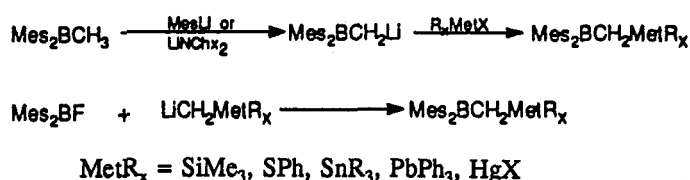
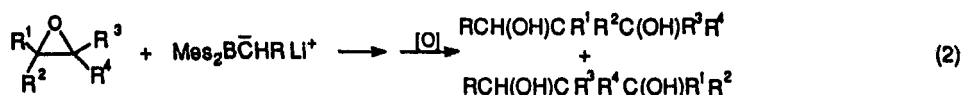

Figure 4

The reactions with epoxides show that steric factors dominate the position of the attack of the carbanions. Overall the reaction gives ready access to 1,3-diols [10] (equation 2).



Steric control of the reactions of dimesitylboryl stabilised carbanions is further illustrated by the reactions of the anion derived from allyldimesitylborane (Figure 5). In all cases attack is entirely at C-3, to yield the corresponding *trans*-alkenylborane. This leads to very efficient three carbon homologation reactions as well as to a lactol synthesis [11].

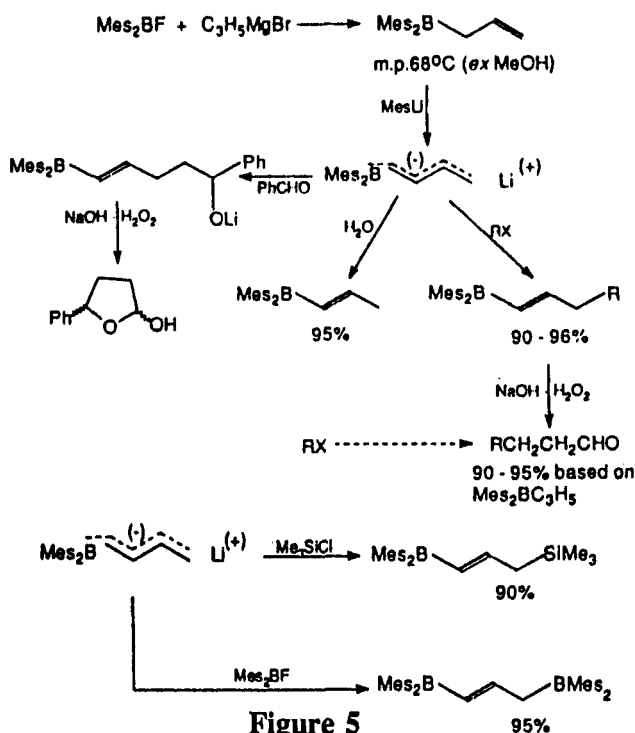
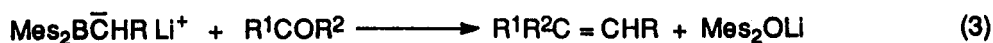

Figure 5

Perhaps the most important reactions that we have discovered in this area involve the condensations of boron stabilised carbanions with aldehydes and ketones. The reaction expected was the production of alkenes according to equation 3.



We first [12] examined the reactions with symmetrical diarylketones so that no stereochemical or enolisation problems would arise. Our results were very satisfactory and are shown in Table 2. They show that a variety of carbanions can be used successfully (exp. 1-3) and that even labile alkenes such as benzofulvene can be prepared by this method (exp. 4,5).

Table 2
The reactions of $\text{Mes}_2\text{BCHLiR}$ with aromatic ketones

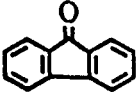
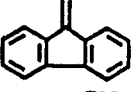
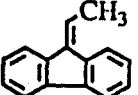
| Exp. | Ketone | R | Alkene Product ^a | Conditions | Yield (%) ^b |
|------|---|---------------------------|---|---------------------------------|------------------------|
| 1 | Ph_2CO | H | $\text{Ph}_2\text{C}=\text{CH}_2$ | 24h, 20°C | 75(95) |
| 2 | " | CH_3 | $\text{Ph}_2\text{C}=\text{CHCH}_3$ | 1h, 0°C; 12h, 20°C | 70(90) |
| 3 | " | C_7H_{15} | $\text{Ph}_2\text{C}=\text{CHC}_7\text{H}_{15}$ | 1h, 0°C; 12h, 20°C | 70(9) |
| 4 |  | H |  | 12h; 20°C ^c | 80 |
| 5 | " | CH_3 |  | 1h, 0°C; 12h, 20°C ^c | 90 |

^a) Alkenes either compared directly with authentic samples or fully characterised.

^b) Isolated yields of purified products (g.c. yields).

^c) Initial product stirred in CHCl_3 for 12h/20°C.

^d) Initial products stirred in CHCl_3 for 3h/20°C.

Benzaldehyde was then examined as a representative aromatic aldehyde. Under the same conditions as used for the ketones no alkene was produced. Lowering the temperature gave rise to some alkene but always less than 50% and always accompanied by ketone, PhCOCH_2R , and alcohol $\text{PhCHOHCH}_2\text{R}$. Our explanation for these products is given in Figure 6.

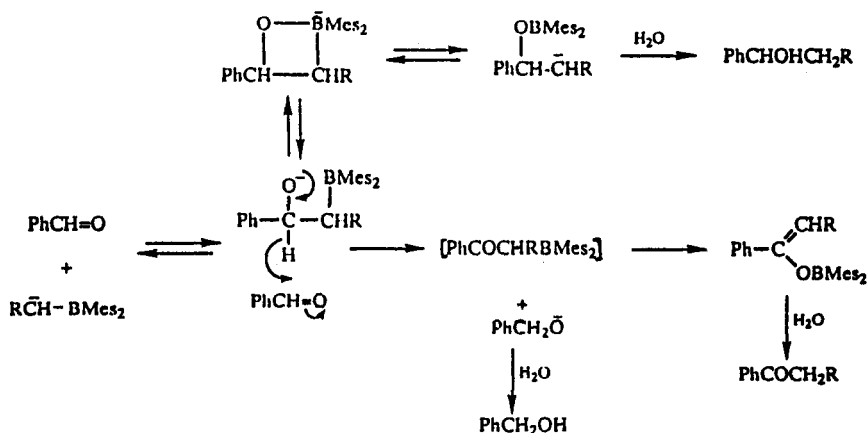
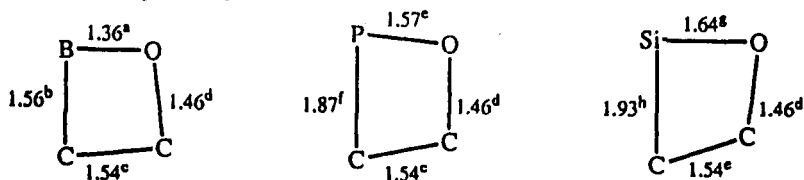

Figure 6

Despite the low yields it was encouraging that the alkene was almost entirely *E*-alkene, in contrast to both the Wittig [13] and Peterson [14] reactions. We had in fact hoped that the reaction would be stereoselective to give *E*-alkenes on the basis of the shorter B-O and B-C bond lengths in a presumed cyclic intermediate as compared with the corresponding P-O and B-C and Si-C and Si-C bond lengths (Figure 7).



a) in B(OH)_3 , B(OMe)_3 ; b) in Me_3B ; c) in $\text{CH}_3\text{-CH}_3$; d) in oxetane;
e) in $(\text{HO})_3\text{P}=\text{O}$; f) in Me_3P ; g) in $(\text{Me}_3\text{Si})_2\text{O}$, h) in Me_4Si .

All bond lengths in Å units, roughly to scale, ignoring bond angles.

Figure 7

In order to gain some insight into the structure of the intermediate that yields alkene, it was decided to carry out some low temperature oxidations using alkaline hydrogen peroxide. This reaction always proceeds with retention [15] and the structure of the 1,2-diol produced would then correlate directly with that of the intermediate. We had expected that the cyclic intermediates that give *E*-alkenes would also give rise to *threo*-1,2-diols. In fact, we obtained the *erythro* isomers!!

It also turned out that this is an efficient and unique process which gives good yields of 1,2-diols even in those cases that gave no alkene at all [16] (equation 4).

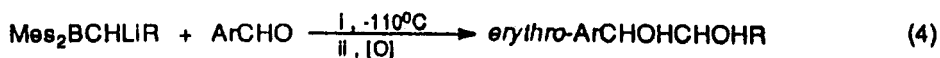

To explain these results we must assume firstly that the initial condensation is highly stereoselective and secondly that the intermediates in this reaction are not oxaboratetanes that undergo *syn* elimination but instead are acyclic and undergo *anti* elimination (Figure 8). An alternative, though unlikely explanation is that the B-C bond is oxidised with inversion of configuration.

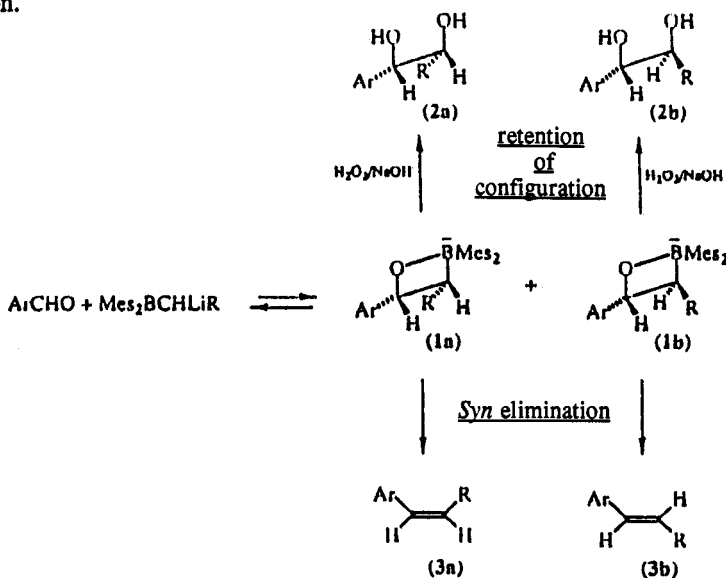

IN FACT (3b) AND (2a) OBTAINED !

∴ EITHER THE OXIDATION IS NOT PROCEEDING WITH RETENTION OR INTERMEDIATE(1a) EXISTS IN THE OPEN CHAIN FORM AND THERE IS *ANTI* ELIMINATION.

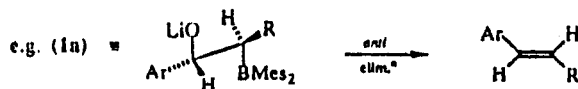

Figure 8

In order to check the nature of the intermediate, it was decided to trap it, and after some experimentation a procedure using low temperature addition of trimethylsilyl chloride was evolved [17]. The products proved to be stable and isolable and a study of their n.m.r. spectra showed clearly that they had the *erythro* configuration, confirming the inferences drawn from the production of diols. Of particular interest was that the silylated intermediates were produced in high yields in all cases, even for those cases that had given little or no alkenes in the direct condensation. It was therefore decided to use the silylated intermediates to attempt to produce alkenes. In practise this was readily accomplished by the addition of aqueous HF in acetonitrile to either the

isolated (procedure B) or non-isolated (procedure A) silylated intermediate.

The alkene so produced was always >95% *E*-alkene, which makes our procedure superior to any comparable condensations. Our interpretation of our results is shown in Figure 9.

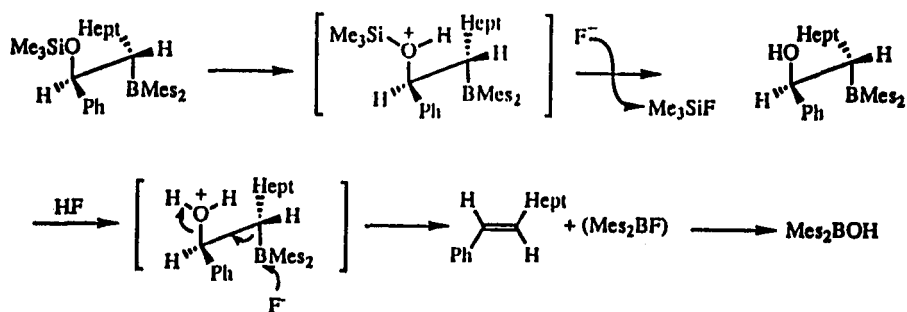

Figure 9

We then wondered whether we could induce *syn* elimination from the initial *erythro* condensation products. An acylated intermediate might favour the required conformation due to attractive forces between the carbonyl oxygen and the boron atom. A unique *syn* elimination akin to an ester elimination but involving the elimination of an acyloxydiarylborane, was envisaged (Figure 10). In the event, addition of trifluoroacetic anhydride at low temperature yielded mainly *Z*-alkenes [17].

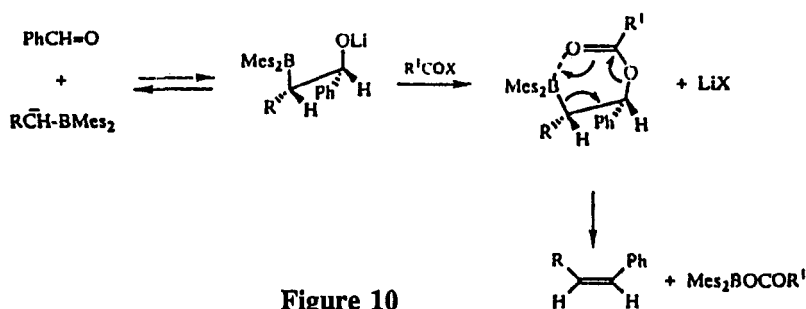

Figure 10

The situation as regards aromatic aldehydes is summarised in Figure 11, which shows the flexibility and usefulness of the reactions.

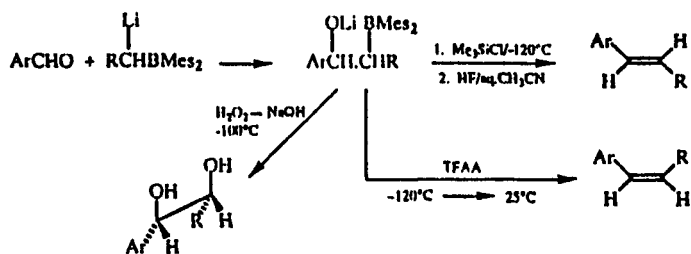

Figure 11

We then examined the reactions of aliphatic aldehydes with boron stabilised carbanions [18,19], with the expectation of producing alkenes as in equation 5.



To our surprise, the condensation of octanal with either $\text{Mes}_2\text{BCHLiHept}$ or $\text{Mes}_2\text{BCHLiProp}$ using a wide variety of conditions gave no alkene but only low yields of ketones $\text{HeptCOCH}_2\text{Hept(Prop)}$. These could have arisen from a hydride transfer of the type shown in Figure 6. To avoid this, either TFAA or TMS chloride was added to discharge the anionic character of the intermediate. However, either one of these reagents led to a strong *enhancement* of the yields of ketones and no alkene at all!

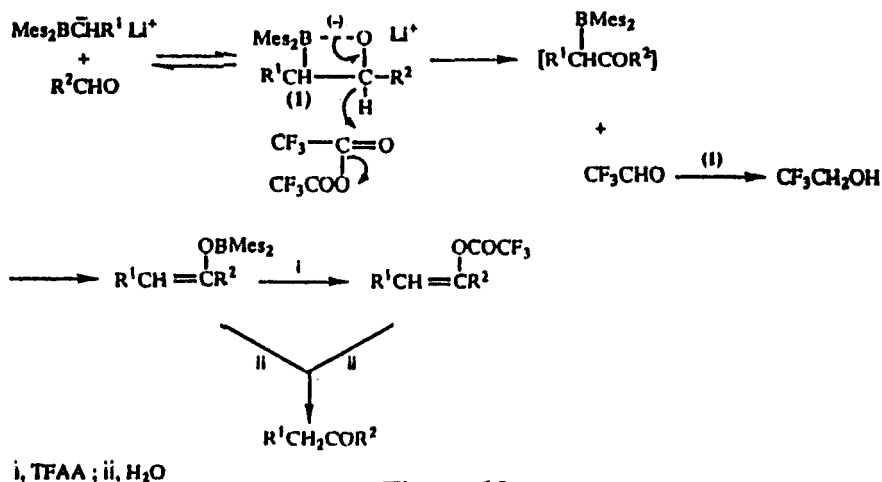
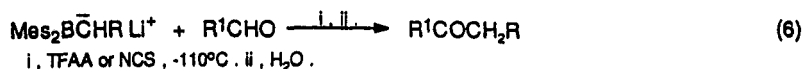

Figure 12

Our hypothesis for the unexpected course taken by the reaction with TFAA is shown in Figure 12, in which TFAA acts as a hydride acceptor and so does trifluoroacetaldehyde, the product of the first reduction. This explains the more than 50% yields of ketone in the unique and useful reaction outlined in equation 6.



The first point to note is that when R^1 is Hept or Prop, excellent yields of ketones result from condensations with MeCHO , $\text{R}^{\text{prim}}\text{CHO}$, $\text{R}^{\text{sec}}\text{CHO}$, $\text{R}^{\text{tert}}\text{CHO}$ and ChxCHO . We assume that anions with alkyl groups higher than propyl will all behave similarly. As the alkyl chain attached to boron becomes short (< four carbon atoms) the course of the reaction is strongly affected. When $\text{R}^1=\text{Et}$ (exp. 11, 12) the yield of ketone is lowered and when $\text{R}^1=\text{H}$, then only alkene is produced. *This is an excellent method for the methylenation of aldehydes* (equation 7).



It is clear that there is a fine balance between redox and elimination reactions that is affected by the length of the alkyl chain attached to boron. We do not know why this should be, but it may reflect the existence of the initial intermediate in either cyclic or acyclic forms. In any case, the use of a more powerful oxidant than TFAA was indicated, and after some experimentation, N-chlorosuccinimide was found to be suitable.

Thus with the exception of $\text{R}^1=\text{H}$, the process shown in equation 6 is a unique and general method for the direct conversion of aldehydes to ketones. When $\text{R}^1=\text{H}$, then the general methylenation process of equation 7 results.

If the hydride transfer depends on the anionic character of the initial condensation product, then neutralisation of the charge by a reagent that was not itself reduced should result in elimination to give alkene. Therefore the aldehyde was added together with a proton source [19]. We had previously [20] used water to control the polycondensation of an anion with an aldehyde and, subsequent to this work, a brief mention appeared of the use of acetic acid to

control the stereochemistry of a Wittig reaction [21]. We further argued that a strong acid might yield a protonated intermediate that would orient itself so as to give *anti*-elimination (Figure 13).

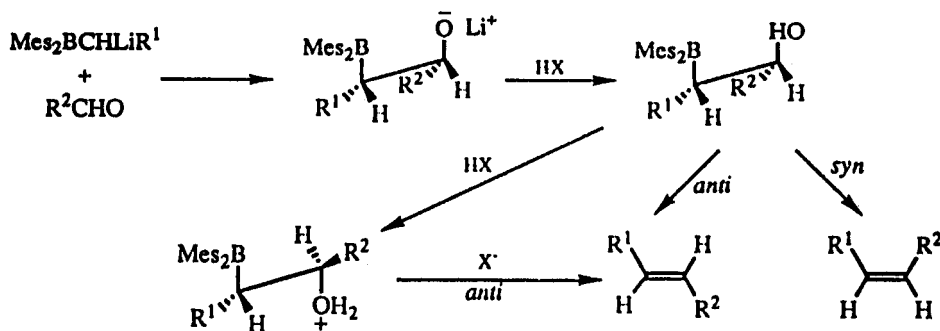
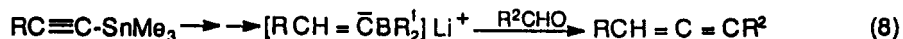

Figure 13

We were pleased to find that condensation did occur, *even* in the presence of strong acids, and that the products are *E*-alkenes in good isolated yields in all cases. Moreover, with $\text{R}^{\text{sec}}\text{CHO}$ and $\text{R}^{\text{tert}}\text{CHO}$, use of weak acids leads to a high preference for *Z*-alkenes. Some of the reversals are quite remarkable and contrast greatly with both the Wittig reaction [13] and the Schlosser modification of the Wittig reaction [22].

Our process does not need any isolation and separation of intermediates as required by the Reterson reaction and proceeds with far better stereoselectivity than the Schlosser modification of the Wittig reaction for the production of *E*-alkenes. As such it should find general application.

Boron stabilised alkenyl carbanions [3] condense with carbonyl compounds to give allenes [23] according to equation 8.



Yields are moderate in most cases (sometimes due to isolation problems), but nevertheless the reaction is a unique and useful allene synthesis.

As an offshoot of this work we had access to a variety of hindered diaryboranes from which to produce novel hydroborating and reducing agents as shown in Figure 14.

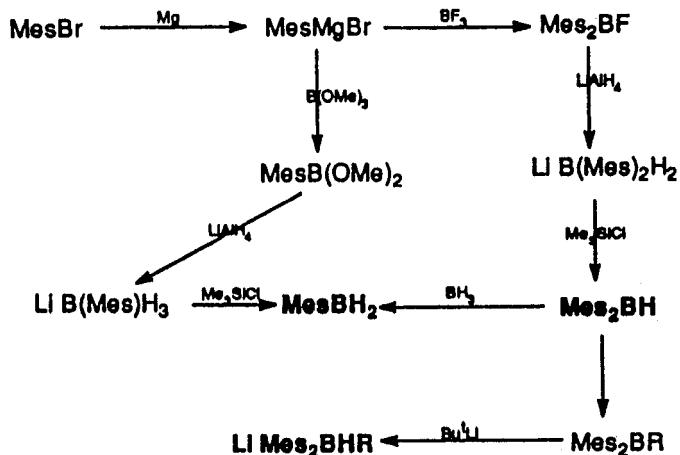
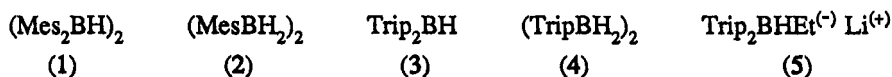

Figure 14

In particular, we have studied the following compounds.



Dimesitylborane (1), now commercially available, proved to be a most useful reagent that solved some selectivity problems that had defeated any other borane [24]. The reagent slowly hydroborated alk-1-enes but hardly touched internal alkenes at room temperature. Reactions with internal or terminal alkynes were relatively fast and in competition experiments any alkyne was hydroborated in preference to any alkene. *Thus the reagent is highly chemoselective.* Moreover, dimesitylborane proved to be the most regioselective of known hydroborating agents for the hydroboration of unsymmetrical internal alkynes (Table 3). As such it is already finding a niche in organic synthesis.

Table 3
Hydroboration of Internal Alkynes by Borane and Diorganylboranes

| Reagent | Pr ^a -C≡C-Me | | Ph-C≡C-Me | |
|----------------------|-------------------------|----|-----------|----|
| | ↑ | ↑ | ↑ | ↑ |
| BH ₃ .THF | 40 | 60 | 74 | 26 |
| Sia ₂ BH | 39 | 61 | 19 | 81 |
| 9-BBN | 27 | 73 | 63 | 35 |
| Mes ₂ BH | 10 | 90 | 2 | 98 |
| Trip ₂ BH | 50 | 50 | 10 | 90 |

Our hopes of finding an even more selective hydroborating agent in ditriptylborane (3) foundered on the fact that this compound proved to be *the only known stable monomeric diorganylborane* [25]. Unlike (1), compound (3) was very soluble in organic solvents, even light petroleum, but unfortunately proved to be one of the *least* selective of known hydroborating agents [26] (Table 3). It does however provide an interesting substrate for the study of the reactions of organoboranes. For example, hydroborations with (1) cannot proceed through an unsolvated monomer or else they would have a low regioselectivity, as evidenced by (3).

In contrast to hexylborane which must be prepared at low temperatures and used immediately [27], monomesitylborane (2) and monotriptylborane (4) [28] are readily available and stable reagents. Thus crystalline (2) had 93% of its original activity after 10 days at room temperature, and a THF solution retained 76% activity after two weeks standing. *For most purposes they can be used as replacement reagents for hexylborane but have some special properties of their own that are not paralleled by hexylborane.*

The first of these is that *both triptylborane and mesitylborane are unique amongst organoboranes in that they hydroborate terminal alkenes in a stepwise fashion* (ea. 9).

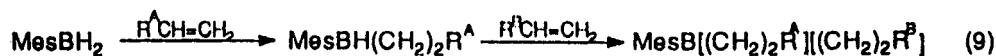

The regiospecificity in the first step is >99% and it is quantitative in the second step.

Mesitylborane can add two primary alkenes *and also two secondary alkenes, without displacement of the hindered aromatic group.* However, attempts to add cyclohexene to MesBH(Ipc) led to substantial displacement of α -pinene.

In order to prove that these hydroboration products could be of synthetic use it was necessary to test the migratory aptitude of the mesityl group relative to the various alkyl groups used. To do this we used the cyanoborate (cyanidation) process [29] as shown in equation 10.

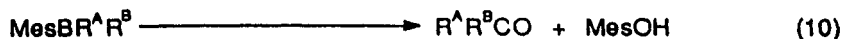

Our results show that indeed the mesityl group has the low migratory aptitude required for synthetic use. In no case could we detect any products derived from the migration of a mesityl group.

Both primary and secondary alkyl groups migrate in preference to a mesityl (or triaryl) group. The unique results of the use of either mesityl or triarylboranes is illustrated by the production of *unsymmetrical* linear ketones. This clearly greatly enlarges the scope of reactions such as the cyanidation of organoboranes. Cyclic hydroborations followed by cyanidation are illustrated in equation 11. The equivalent reaction with thexylborane also goes but gives a much less pure product, perhaps due to the initial hydroboration being less selective.

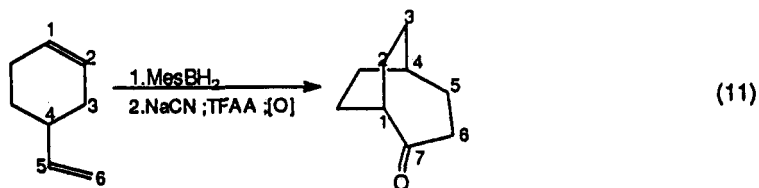

At this point the hydroboration/cyanidation of limonene (equation 12) was attempted using mesitylborane. However this sequence, which was successful with thexylborane [30], *essentially failed with mesitylborane (3% yield)*. This is due to the greater facility of thexylborane, as compared with mesitylborane, for the hydroboration of more hindered double bonds, and defines at least one area in which thexylborane will retain its use.

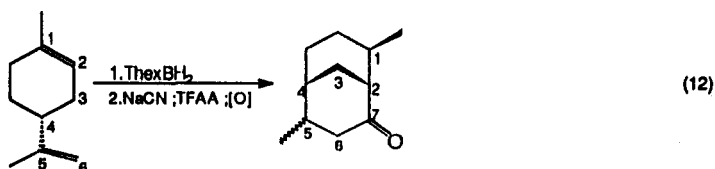

We next examined the displacement of the aromatic group from hydroboration products and found two unusual and highly selective processes that further enhance the usage of mesitylborane. The first is illustrated in equation 13.



Yields of alcohols are between 82-87%. More importantly, the intermediate dialkylmethoxyborane can be reacted directly with a Grignard reagent to give a fully mixed organoborane, in which all the alkyl groups are primary, and which in turn can be readily converted to the corresponding carbinol [31] (equation 14).

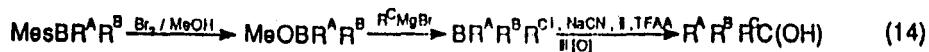

In the case in which $\text{R}^A = n\text{-octyl}$, $\text{R}^B = n\text{-hexyl}$, $\text{R}^C = n\text{-butyl}$, the overall yield of isolated carbinol, based on MesBH_2 , is 69%, an excellent yield given the seven steps involved. A different method of releasing the mesityl or triaryl groups is through direct reaction with alkyl or aryllithiums (equation 15). Cyanidation converts the product to the corresponding carbinol showing that there has been little, if any, scrambling of the alkyl groups. The mesityl group, presumably displaced as mesityllithium, is recovered as mesitylene (88%) on work-up.

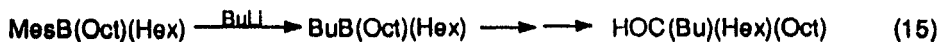

We are currently beginning a study of the properties of compounds such as $\text{Trip}_2\text{BHEt}^{(-)}\text{Li}^{(+)}$ [31]. These are extremely stable compounds, readily made either by the action of *t*-butyllithium or a metal hydride on the borane and in their reduction of substituted cyclohexanones they are highly stereoselective. They possess one very great advantage over,

for example lithium Selectride, in that there is no need for an oxidation step, and the product borane is so stable that on aqueous work-up it can be recovered almost quantitatively in the light petrol fraction from a silica column. The boranes can also be used catalytically.

In the same vein we find very ready reductions of alkyl halides, the bromides and iodides in particular, to the corresponding alkanes with easy work-up and recovery of the borane. Other types of reduction will be reported in due course.

Summary It is clear that hindered organoboranes offer a wide variety of new reagents and reactions to enlarge both the theory and practise of organic chemistry.

Acknowledgement

This work owes much to various collaborations, in particular with Dr. John Wilson and Professor Keith Smith and to many dedicated colleagues including Drs. B. Singaram, L. Warren, E. Colclough, M. Rowlands, G. Vaughan-Williams, S. Elgandy, A. Norbury and Mr. Zhao Jin. We thank the SERC for financial support.

REFERENCES

1. G. W. Spitznagel, T. Clark, J. Chandrasekhar and P. von R. Schleyer, *J. Comput. Chem.*, **3**, 363, (1982).
2. A. Pross, D. J. DeFrees, B. A. Levi, S. K. Pollack, L. Radom, W. J. Hehre, *J. Org. Chem.*, **46**, 1693, (1981).
3. A. Pelter, K. Smith, D. E. Parry and K. D. Jones, *Aust. J. Chem.*, **45**, 57, (1992).
4. A. Pelter, B. Singaram, L. Warren and J. W. Wilson, *Tetrahedron*, **49**, 2965, (1993).
5. M. M. Olstead, P. P. Power and K. J. Weese, *J. Am. Chem. Soc.*, **109**, 2541, (1987).
6. N. M. D. Brown, F. Davidson and J. W. Wilson, *J. Organomet. Chem.*, **210**, 1, (1981).
7. A. Pelter, R. Drake and M. Stewart, *Tetrahedron Lett.*, **30**, 3085, (1989).
8. D. S. Matteson and R. J. Moody, *Organometallics*, **1**, 20, (1982).
9. J. W. Wilson, A. Pelter, M. V. Garad and R. Pardasani, *Tetrahedron*, **49**, 2979, (1993).
10. A. Pelter, G. F. Vaughan-Williams and R. M. Rosser, *Tetrahedron*, **49**, 3007, (1993).
11. A. Pelter, B. Singaram and J. W. Wilson, *Tetrahedron Lett.*, **24**, 631, (1983).
12. A. Pelter, B. Singaram and J. W. Wilson, *Tetrahedron Lett.*, **24**, 635, (1983).
13. B. E. Maryanoff and A. B. Reitz, *Chem. Rev.*, **89**, 853, (1989).
14. F. F. Hudrlik, D. Peterson and R. J. Rona, *J. Org. Chem.*, **40**, 2263, (1975).
15. A. Pelter, K. Smith and H. C. Brown, 'Borane Reagents', Academic Press, London, UK, (1988).
16. A. Pelter, D. Buss and A. Pitchford, *Tetrahedron Lett.*, **26**, 5093, (1985).
17. A. Pelter, D. Buss, E. Colclough and B. Singaram, *Tetrahedron* **49**, 7077, (1993).
18. A. Pelter, K. Smith, S. Elgandy and Martin Rowlands, *Tetrahedron*, **49**, 7104, (1993).
19. A. Pelter, K. Smith and S. Elgandy, *Tetrahedron*, **49**, 7119, (1993).
20. A. Pelter, R. T. H. Al-Bayati, M. T. Ayoub, W. Lewis and P. Pardasani, *J. Chem. Soc., Perkin Trans. 1*, 717, (1987).
21. B. M. Trost, S. M. Mignani and T. N. Nanninga, *J. Am. Chem. Soc.*, **110**, 1602, (1988).
22. M. Schlosser and H. B. Tuong, *Angew Chem. Int. Ed. Engl.*, **18**, 633, (1979).
23. A. Pelter, K. Smith and K. D. Jones, *J. Chem. Soc., Perkin Trans. 1*, 747, (1992).
24. A. Pelter, B. Singaram and H. C. Brown, *Tetrahedron Lett.*, (1983). **24**, 1433, (1983).
25. R. A. Bartlett, H. V. R. Dias, M. M. Olmstead, P. P. Power and K. J. Weese, *Organometallics*, **9**, 146, (1990).
26. A. Pelter, K. Smith, D. Buss and A. Norbury, *Tetrahedron Lett.*, **32**, 6239, (1991).
27. H. C. Brown, "Organic Syntheses via Boranes", Wiley Interscience, New York, (1975).
28. K. Smith, A. Pelter and Zhao Jin, *J. Chem. Soc., Perkin Trans. 1*, 395, (1993).
29. A. Pelter, K. Smith and Zhao Jin, Unpublished results.
30. A. Pelter, K. Smith, M. G. Hutchings and K. Rowe, *J. Chem. Soc., Perkin 1*, 129, (1975).
31. A. Pelter, M. G. Hutchings, K. Rowe and K. Smith, *J. Chem. Soc., Perkin 1*, 138, (1975).
32. K. Smith, A. Pelter and A. Norbury, *Tetrahedron Lett.*, **32**, 6243, (1991).