

INTERNATIONAL UNION OF PURE AND APPLIED CHEMISTRY

MACROMOLECULAR DIVISION  
COMMISSION ON MACROMOLECULAR NOMENCLATURE\*

## DEFINITIONS OF BASIC TERMS RELATING TO LOW-MOLAR-MASS AND POLYMER LIQUID CRYSTALS

(IUPAC Recommendations 2001)

*Prepared for publication by*  
M. BARÓN

*Facultad de Ciencias Exactas y Naturales, Universidad de Belgrano, Buenos Aires, Argentina*

This document was prepared by a Working Group consisting of:

C. Noël (France); V. P. Shibaev (Russia); M. Barón (Argentina); M. Hess (Germany); A. D. Jenkins (UK); Jung-II Jin (Korea); A. Sirigu (Italy); R. F. T. Stepto (UK); and W. J. Work (USA); with contributions from G. R. Luckhurst (UK); S. Chandrasekhar (India); D. Demus (Germany); J. W. Goodby (UK); G. W. Gray (UK); S. T. Lagerwall (Sweden); O. D. Lavrentovich (USA); M. Schadt (Switzerland), of the International Liquid Crystal Society.

\*Membership of the Commission during the preparation of this report (1987–97) was as follows:

**Titular Members:** G. Allegra (Italy, to 1990); R. E. Bareiss (Germany, to 1994); M. Barón (Argentina, National Representative from 1988, Associate Member from 1992, Titular Member from 1996); N. M. Bikales (USA, Secretary to 1988); K. Hatada (Japan, Associate Member from 1988, Titular Member from 1990); J. Kahovec (Czech Republic, Associate Member from 1988, Titular Member from 1992); P. Kratochvíl (Czech Republic, Chairman to 1992), E. Maréchal (France, Associate Member from 1992, Titular Member from 1994); W. V. Metanomski (USA, Associate Member from 1988, Titular Member from 1992); I. Mita (Japan, to 1990, Associate Member to 1992); C. Noël (France, to 1994); I. M. Papisov (USSR, to 1988, Associate Member to 1992); V. P. Shibaev (Russia, 1996, Associate Member from 1996); R. F. T. Stepto (UK, Associate Member from 1988, Titular Member from 1990, Chairman from 1992); U. W. Suter (Switzerland, to 1992, Associate Member from 1992); W. J. Work (USA, Associate Member from 1986, Secretary from 1988).

**Associate Members contributing to this report:** J. V. Alemán (Spain, 1996); A. D. Jenkins (UK, Associate Member to 1988); M. Hess (Germany, from 1996), J.-I. Jin (Korea, National Representative from 1992, Associate Member from 1994); K. Matyjaszewski (USA, 1992–1996); S. Penczek (Poland, from 1994); S. Tripathy (USA, to 1992); L. Shi (PR China, 1988–1996). Others contributing to this report: H. J. Coles (UK); R. B. Fox (USA); N. A. Platé (Russia, National Representative); A. Sirigu (Italy, National Representative).

---

*Republication or reproduction of this report or its storage and/or dissemination by electronic means is permitted without the need for formal IUPAC permission on condition that an acknowledgment, with full reference to the source along with use of the copyright symbol ©, the name IUPAC, and the year of publication, are prominently visible. Publication of a translation into another language is subject to the additional condition of prior approval from the relevant IUPAC National Adhering Organization.*

# Definitions of basic terms relating to low-molar-mass and polymer liquid crystals

## (IUPAC Recommendations 2001)

*Abstract:* This document is the first published by the IUPAC Commission on Macromolecular Nomenclature dealing specifically with liquid crystals. Because of the breadth of its scope, it has been prepared in collaboration with representatives of the International Liquid Crystal Society.

The document gives definitions of terms related to low-molar-mass and polymer liquid crystals. It relies on basic definitions of terms that are widely used in the field of liquid crystals and in polymer science. The terms are arranged in five sections dealing with general definitions of liquid-crystalline and mesomorphic states of matter, types of mesophases, optical textures and defects of liquid crystals, the physical characteristics of liquid crystals (including electro-optical and magneto-optical properties), and finally liquid-crystal polymers. The terms that have been selected are those most commonly encountered in the conventional structural, thermal, and electro-optical characterization of liquid-crystalline materials.

### CONTENTS

1. INTRODUCTION
2. GENERAL DEFINITIONS
3. TYPES OF MESOPHASE
4. TEXTURES AND DEFECTS
5. PHYSICAL CHARACTERISTICS OF LIQUID CRYSTALS
6. LIQUID-CRYSTAL POLYMERS
7. REFERENCES
8. ALPHABETICAL INDEX OF TERMS
9. GLOSSARY OF RECOMMENDED ABBREVIATIONS AND SYMBOLS

### 1. INTRODUCTION

This document provides definitions of the basic terms that are widely used in the field of liquid crystals and in polymer science (see refs. 1–39). It is the first publication of the Commission on Macromolecular Nomenclature dealing specifically with liquid crystals.

The recommendations made, resulting from the joint effort of the IUPAC Commission IV.1 Working Party and members of the International Liquid Crystal Society, are concerned with terminology relating to low-molar-mass and liquid-crystal polymers. Since much of the terminology is common to both classes of liquid crystals, this document has not been divided into sections dealing separately with these two classes of substances. After some general definitions (Section 2), there are sections dealing successively with the structures and optical textures of liquid crystals (Sections 3 and 4), their physical characteristics (including electro-optical and magneto-optical properties; Section 5), and finally liquid-crystal polymers (Section 6). An alphabetical index of terms and a glossary of recommended symbols are provided for the convenience of the reader.

Implied definitions, occurring in Notes to the main definitions, are indicated by using bold type for the terms so defined.

## 2. GENERAL DEFINITIONS

### 2.1 mesomorphic state mesomorphous state

A state of matter in which the degree of molecular order is intermediate between the perfect three-dimensional, long-range positional and orientational order found in solid crystals and the absence of long-range order found in isotropic liquids, gases, and amorphous solids.

*Notes:*

1. The term mesomorphic state has a more general meaning than “liquid-crystal state” (see Definition 2.2), but the two are often used as synonyms.
2. The term is used to describe orientationally disordered crystals, crystals with molecules in random conformations (i.e., conformationally disordered crystals), plastic crystals, and liquid crystals (see Definition 2.3).
3. A compound that can exist in a mesomorphic state is usually called a **mesomorphic compound** (see Definition 2.11).
4. A vitrified substance in the mesomorphic state is called a **mesomorphic glass** and is obtained, for example, by rapid quenching or by crosslinking.

### 2.2 liquid-crystal state liquid-crystalline state *Recommended abbreviation: LC state*

A mesomorphic state having long-range orientational order and either partial positional order or complete positional disorder.

*Notes:*

1. In the LC state, a substance combines the properties of a liquid (e.g., flow, ability to form droplets) and a crystalline solid (e.g., anisotropy of some physical properties).
2. The LC state occurs between the crystalline solid and the isotropic liquid states on varying, for example, the temperature.

#### 2.2.1 liquid-crystalline phase *Recommended abbreviation: LC phase*

A phase occurring over a definite temperature range within the LC state.

### 2.3 liquid crystal *Recommended abbreviation: LC*

A substance in the LC state.

*Note:* A pronounced anisotropy in the shapes and interactions of molecules, or molecular aggregates is necessary for the formation of liquid crystals.

### 2.4 mesophase

A phase occurring over a definite range of temperature, pressure, or concentration within the mesomorphic state.

#### 2.4.1 enantiotropic mesophase

A mesophase that is thermodynamically stable over a definite temperature or pressure range.

*Note:* The range of thermal stability of an enantiotropic mesophase is limited by the melting point and the clearing point of an LC compound (see Definition 2.6) or by any two successive mesophase transitions.

#### 2.4.2 *thermotropic mesophase*

A mesophase formed by heating a solid or cooling an isotropic liquid, or by heating or cooling a thermodynamically stable mesophase.

*Notes:*

1. The adjective “thermotropic” describes a change of phase with a change of temperature. “Thermotropic” may also be used to qualify types of mesophase (e.g., thermotropic nematic).
2. Analogous changes can also occur on varying the pressure in which case the mesophase may be termed **barotropic mesophase**.

#### 2.4.3 *lyotropic mesophase*

A mesophase formed by dissolving an amphiphilic mesogen in a suitable solvent, under appropriate conditions of concentration, temperature, and pressure.

*Notes:*

1. The essential feature of a lyotropic liquid crystal is the formation of molecular aggregates or micelles as a result of specific interactions involving the molecules of the amphiphilic mesogen and those of the solvent.
2. See Definition 2.11.1 for the definition of an amphiphilic mesogen.
3. The mesomorphic character of a lyotropic mesophase arises from the extended, ordered arrangement of the solvent-induced micelles. Hence, such mesophases should be regarded as based not on the structural arrangement of individual molecules (as in a nonamphiphilic or a thermotropic mesophase), but on the arrangement within multimolecular domains.

#### 2.4.4 *amphitropic compound*

A compound that can exhibit thermotropic as well as lyotropic mesophases.

*Note:* Examples are potassium salts of unbranched alkanolic acids, lecithin, certain polyisocyanates, cellulose derivatives with long side-chains, such as (2-hydroxypropyl)cellulose, and cyanobiphenyl derivatives of alkyl(triethyl)ammonium bromide.

#### 2.4.5 *monotropic mesophase*

A metastable mesophase that can be formed by supercooling an isotropic liquid or an enantiotropic mesophase at a given pressure to a temperature below the melting point of the crystal.

*Note:* Monotropic transition temperatures (see Definition 2.5.) are indicated by placing parentheses, (), around the values.

### 2.5 **transition temperature**

**Recommended symbol:**  $T_{XY}$

**SI unit:** K

The temperature at which the transition from mesophase X to mesophase Y occurs.

*Note:* Mesophase X should be stable at lower temperatures than phase Y. For example, the nematic-isotropic transition temperature would be denoted as  $T_{NI}$ .

### 2.6 **clearing point**

**clearing temperature**

**isotropization temperature**

**Recommended symbol:**  $T_{cl}$  or  $T_i$

**SI Unit:** K

The temperature at which the transition between the mesophase with the highest temperature range and the isotropic phase occurs.

*Note:* The term should only be used when the identity of the mesophase preceding the isotropic phase is unknown.

## 2.7 virtual transition temperature

A transition temperature that cannot be measured directly, determined by extrapolation of transition lines in binary phase diagrams to 100% of that particular component.

*Notes:*

1. A virtual transition temperature lies outside the temperature range over which the (meso) phase implied can be observed experimentally.
2. A virtual transition temperature is not well defined; it will, for example, depend on the nature of the liquid-crystal components used to construct the phase diagram.
3. A virtual transition temperature is indicated by placing square brackets, [ ], around its value.

## 2.8 transitional entropy

**Recommended symbol:**  $\Delta S_{XY}$

**SI unit:**  $\text{J K}^{-1} \text{mol}^{-1}$

The change in entropy on transition from phase X to phase Y.

*Notes:*

1. The transitional entropy reflects the change in order, both orientational and translational, at the phase transition.
2. Phase X should be stable at lower temperatures than phase Y.
3. Numerical values of the molar transitional entropy should be given as the dimensionless quantity  $\Delta S_{XY}/R$  where  $R$  is the gas constant.

## 2.9 divergence temperature pretransitional temperature

**Recommended symbol:**  $T^*$

**SI Unit:** K

The temperature at which the orientational correlations in an isotropic phase diverge.

*Notes:*

1. The divergence temperature is the lowest limit of metastable supercooling of the isotropic phase.
2. The divergence occurs at the point where the isotropic phase would be expected to undergo a second-order transition to the liquid-crystal phase, were it not for the intervention of a first-order transition to the liquid-crystal phase.
3. The divergence temperature for nematogens can be measured by using the Kerr effect or Cotton–Mouton effect or by light-scattering experiments.
4.  $T^*$  occurs below the clearing temperature, usually by about 1 K in isotropic-to-nematic transitions and increases to at least 10 K for isotropic-to-smectic transitions.

## 2.10 mesogenic group mesogenic unit mesogenic moiety

A part of a molecule or macromolecule endowed with sufficient anisotropy in both attractive and repulsive forces to contribute strongly to LC mesophase, or, in particular, to LC mesophase formation in low-molar-mass and polymeric substances.

*Notes:*

1. “Mesogenic” is an adjective that in the present document applies to molecular moieties that are structurally compatible with the formation of LC phases in the molecular system in which they exist.
2. Mesogenic groups occur in both low-molar-mass and polymeric compounds.
3. The majority of mesogenic groups consist of rigid rod-like or disc-like molecular moieties.

Examples of mesogenic groups are

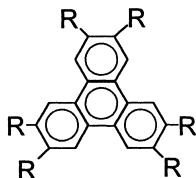
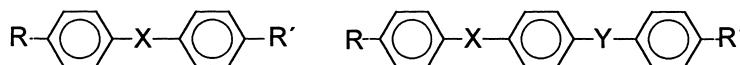

where X and Y are covalent bonds or linking units such as:

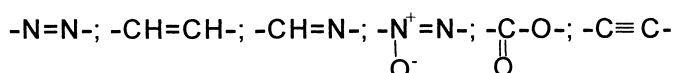

### 2.11 mesogen mesogenic compound mesomorphic compound

A compound that under suitable conditions of temperature, pressure, and concentration can exist as a mesophase, or, in particular as a LC phase.

*Notes:*

1. When the type of mesophase formed is known, more precisely qualifying terminology can be used, e.g., **nematogen**, **smectogen**, and **chiral nematogen**.
2. When more than one type of mesophase can be formed, more than one qualification could apply to the same compound, and then the general term mesogen should be used.

#### 2.11.1 amphiphilic mesogen

A mesogen composed of molecules consisting of two parts of contrasting character that are hydrophilic and hydrophobic or lipophobic and lipophilic.

*Notes:*

1. Examples of amphiphilic mesogens are soaps, detergents, and some block copolymers.
2. Under suitable conditions of temperature and concentration, the similar parts of amphiphilic molecules cluster together to form aggregates or micelles (see Definition 2.4.2).

#### 2.11.2 nonamphiphilic mesogen

A mesogen that is not of the amphiphilic type.

*Notes:*

1. At one time it was thought that a nonamphiphilic molecule had to be long and rod-like for mesophase formation, but it has now been established that molecules of other types and shapes, for example, disc-like and banana-shaped molecules, may also form mesophases. (See ref. 6).
2. A selection of the types of nonamphiphilic mesogens is given in definitions 2.11.2.1.–2.11.2.8.

##### 2.11.2.1 calamitic mesogen

A mesogen composed of rod- or lath-like molecules.

*Note:* Examples are:

- 4-butyl-*N*-(4-methoxybenzylidene)aniline (BMBA) (a)
- 4,4'-dimethoxyazoxybenzene (b)
- 4-cyano-4'-pentylbiphenyl (c)

- 4-(*trans*-4-pentylcyclohexyl)benzointrile (d)
- cholesterol and cholest-5-ene-3-carboxylic acid esters (e).

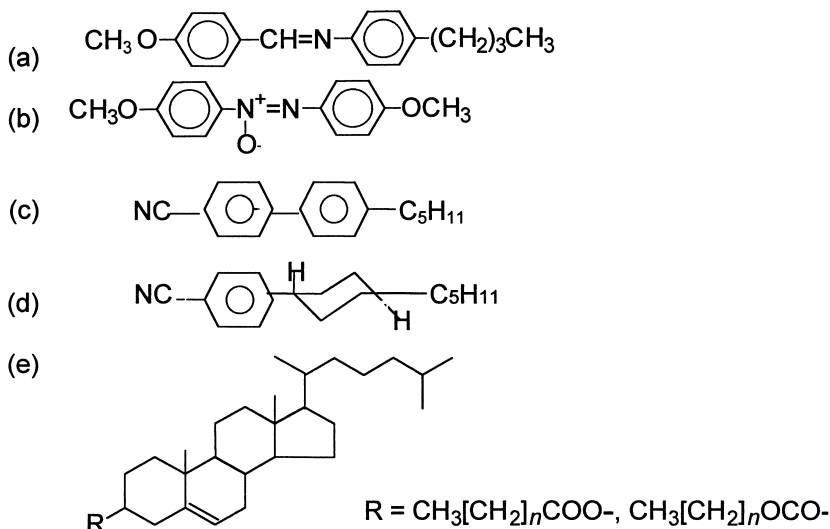

#### 2.11.2.2 discotic mesogen discoid mesogen

A mesogen composed of relatively flat, disc- or sheet-shaped molecules.

*Notes:*

1. Examples are: hexa(acyloxy)benzenes (a), hexa(acyloxy)- and hexa-alkyloxytriphenylenes (b), 5*H*,10*H*,15*H*-diindenol[1,2-*a*:1',2'-*c*]fluorene derivatives (c).

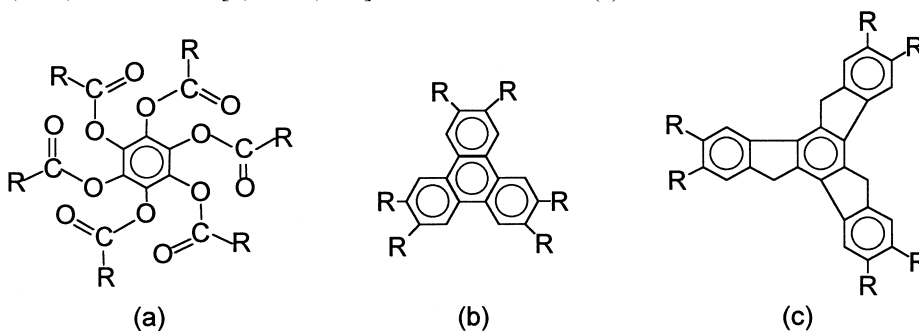

Examples of some appropriate substituent groups are:

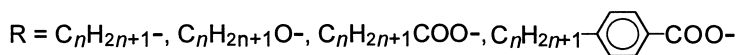

2. The adjective “discotic” is also employed to describe the nematic mesophases formed by discotic mesogens. The mesophases formed by a columnar stacking of disc-like molecules are described as columnar mesophases (see Definitions 3.2).

#### 2.11.2.3 pyramidal mesogen conical or cone-shaped mesogen bowllic mesogen

A mesogen composed of molecules containing a semi-rigid conical core.

*Note:* Examples are hexasubstituted 5*H*,10*H*,15*H*-dihydrotribenzo[*a,d,g*][9]annulenes.

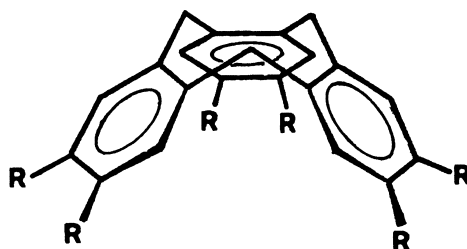

#### 2.11.2.4 sandwich mesogen

A mesogen composed of board-like molecules with the long-range orientational order of the phase reflecting the symmetry of the constituent molecules.

*Note:* See also Definition 3.4.

#### 2.11.2.5 polycatenary mesogen

A mesogen composed of molecules each having an elongated rigid core with several flexible chains attached to the end(s).

*Notes:*

1. The flexible chains are usually aliphatic.
2. The numbers of flexible chains at the ends of the core can be indicated by using the term ***m,n*-polycatenary mesogen**.
3. There exist several descriptive names for these mesogens. Examples are: (a) **biforked mesogen** (2,2-polycatenary mesogen); (b) **hemiphasmidic mesogen** (3,1-polycatenary mesogen); (c) **forked hemiphasmidic mesogen** (3,2-polycatenary mesogen); and (d) **phasmidic mesogen** (3,3-polycatenary mesogen). Examples of each type with the core represented by are given together with a specific example of a forked hemiphasmidic mesogen (c).

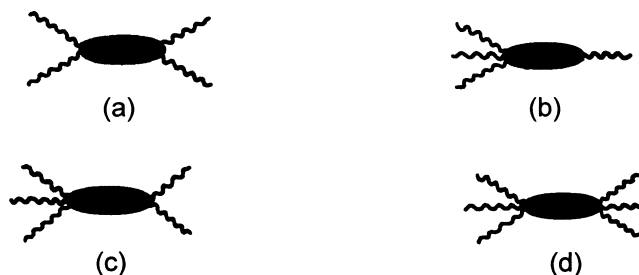

A specific example of (c) is

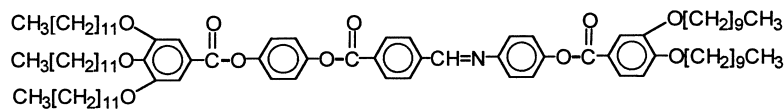

#### 2.11.2.6 swallow-tailed mesogen

A mesogen composed of molecules each with an elongated rigid core with, at one end, a branched flexible chain, having branches of about the same length.

*Note:* A sketch of the structure of a swallow-tailed mesogen is





and an example is the fluorene derivative

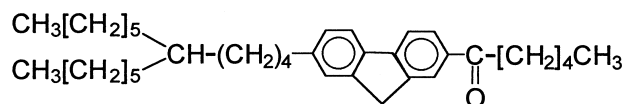

#### 2.11.2.7 bis-swallow-tailed mesogen

A mesogen composed of molecules each with an elongated rigid core and a branched flexible chain, with branches of about the same length, attached at each end.

Example:

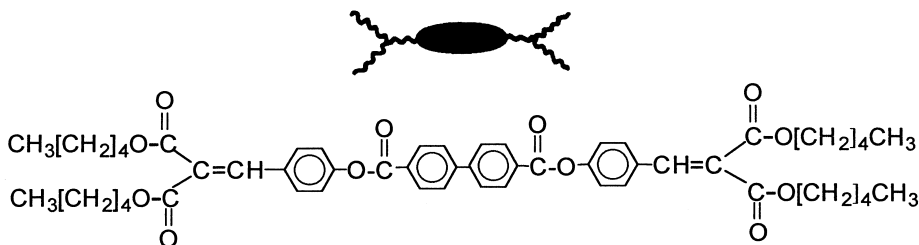

#### 2.11.2.8 laterally branched mesogen

A mesogen composed of rod-like molecules with large lateral branches such as alkyl, alkoxy, or ring-containing moieties.

Example:

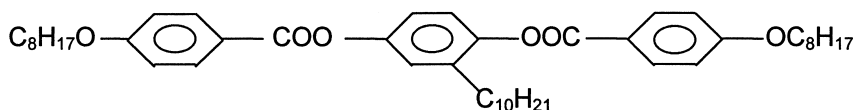

#### 2.11.2.9 liquid-crystal oligomer mesogenic oligomer

A mesogen constituted of molecules, each with more than one mesogenic group.

Notes:

1. The mesogenic groups usually have identical structures.
2. A **liquid-crystal dimer** or **mesogenic dimer** is sometimes known as a **twin mesogen**. Use of the terms “dimesogenic compounds” and “Siamese-twin mesogen” for “liquid-crystal dimer” or “mesogenic dimer” is not recommended.
3. Examples of mesogenic dimers are: (a) **fused twin mesogen**, where the mesogenic groups are linked rigidly by a (usually fused) ring system; (b) **ligated twin mesogen**, in which the mesogenic groups are connected by a **spacer** (see Definition 6.4) at a central position; (c) **tail-to-tail twin mesogen**, which has a flexible spacer linking the two groups; and (d) **side-to-tail twin mesogen**. The structures of these different types of liquid-crystal dimers are illustrated with the mesogenic groups represented by

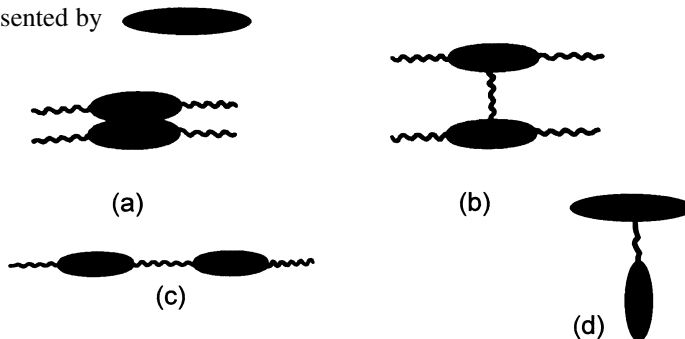

A specific example of type (c), a tail-to-tail liquid-crystal dimer, is

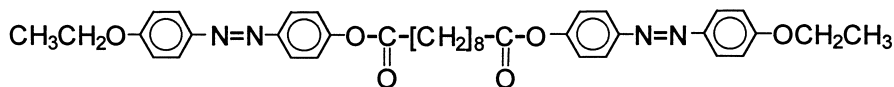

wherein  $-\text{[CH}_2\text{]}_8-$  is the flexible spacer linking the two mesogenic groups.

4. A liquid-crystal dimer with different mesogenic groups linked by a spacer is known as an **asymmetric liquid-crystal dimer**.
5. A liquid-crystal dimer with flexible hydrocarbon chains having an odd number of carbon atoms is called an **odd-membered liquid-crystal dimer**, while one with hydrocarbon chains having an even number of carbon atoms is called an **even-membered liquid-crystal dimer**.

#### 2.11.2.10 banana mesogen

A mesogen constituted of bent or so-called banana-shaped molecules in which two mesogenic groups are linked through a semi-rigid group in such a way as not to be colinear.

*Note:* Examples of such structures are

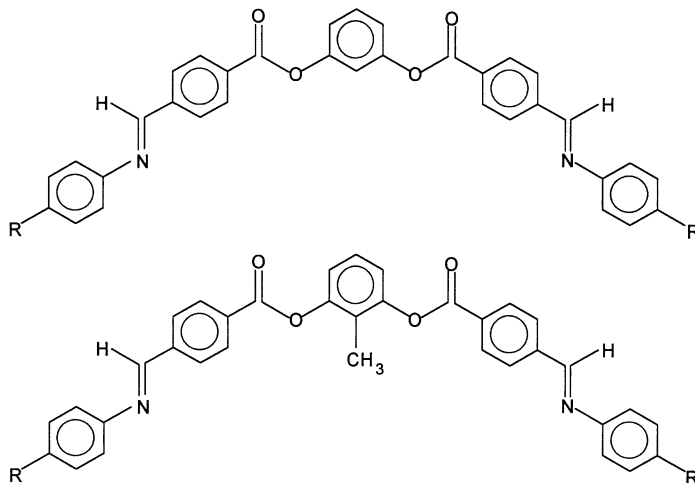

with the substituent group R being an alkyl ether ( $-\text{OC}_n\text{H}_{2n+1}$ )

#### 2.11.3 metallomesogen

A mesogen composed of molecules incorporating one or more metal atoms.

*Notes:*

1. Metallomesogens may be either calamitic (see Definition 2.11.2.1) or discotic (see Definition 2.11.2.2).
2. Examples of metallomesogens are

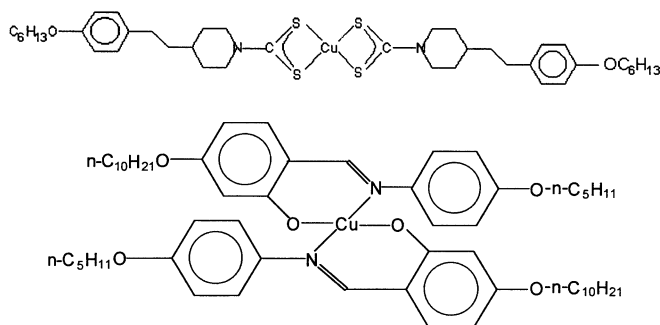

### 3. TYPES OF MESOPHASE

#### 3.1 mesophases of calamitic mesogens

##### 3.1.1 uniaxial nematic mesophase nematic

*Recommended symbol:* N or N<sub>u</sub>

A mesophase formed by a nonchiral compound or by the racemate of a chiral compound in which the spatial distribution of the molecular centers of mass is devoid of long-range positional order and the molecules are, on average, orientationally ordered about a common axis defined as the director and represented by the unit vector  $n$ .

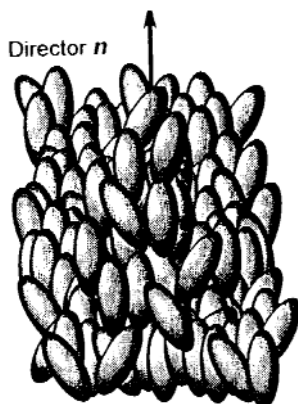

**Fig. 1** A representation of the molecular organization in a uniaxial nematic mesophase.

*Notes:*

1. See Fig. 1 for an illustration of the molecular organization in a uniaxial nematic mesophase.
2. The unit vector,  $n$ , is defined in 3.1.1.1 (see also Fig. 1).
3. The direction of  $n$  is usually arbitrary in space.
4. The extent of the positional correlations for the molecules in a nematic phase is comparable to that of an isotropic phase, although the distribution function is necessarily anisotropic.
5. From a crystallographic point of view, the uniaxial nematic structure is characterized by the symbol  $D_{\infty h}$  in the Schoenflies notation ( $\infty/mm$  in the International System).
6. Since the majority of nematic phases are uniaxial, if no indication is given, a nematic phase is assumed to be uniaxial but, when there is the possibility of a biaxial as well a uniaxial nematic, a uniaxial phase should be denoted as N<sub>u</sub> (see Definition 3.3.1).

##### 3.1.1.1 director

*Recommended symbol:*  $n$

The local symmetry axis for the singlet, orientational distribution of the molecules of a mesophase.

*Notes:*

1. The director is defined as a unit vector, but directions  $+n$  and  $-n$  are arbitrary.
2. In uniaxial nematics, formed by compounds consisting of either rod- or disc-like molecules, the mean direction of the effective molecular symmetry axis coincides with the director.
3. The director also coincides with a local symmetry axis of any directional property of the mesophase, such as the refractive index or magnetic susceptibility.

##### 3.1.2 cybotactic groups

An assembly of molecules in a nematic mesophase having a short-range smectic-like array of the constituent molecules.

*Note:* Two types of short-range smectic-like structures are possible. One is analogous to a smectic A mesophase where the molecules tend to lie along a layer normal (see Definition 3.1.5.1.1), and the other is like a smectic C mesophase (see Definition 3.1.5.1.2) where the molecules tend to be oblique with respect to a layer normal. See Fig. 2 for illustrations of the molecular arrangements in the smectic A-type structure and the smectic C-type structure.

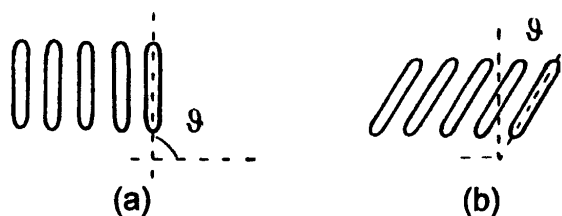

**Fig. 2** Schematic representation of the molecules in (a) a smectic A-like local structure and (b) a smectic C-like local structure, making angle  $\vartheta$  with the layer normal.

### 3.1.3 chiral nematic mesophase

*chiral nematic*

*cholesteric mesophase*

*cholesteric*

*Recommended symbol: N\**

A mesophase with a helicoidal superstructure of the director, formed by chiral, calamitic, or discotic molecules or by doping a uniaxial nematic host with chiral guest molecules in which the local director  $n$  precesses around a single axis.

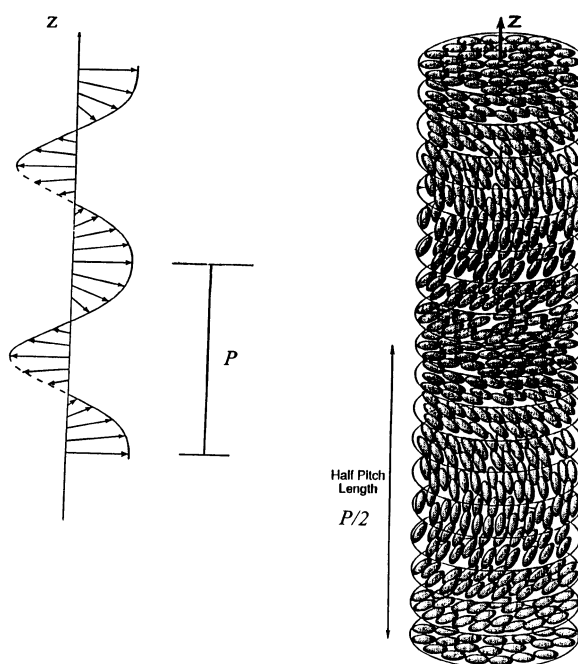

**Fig. 3** Illustrating the structure of a chiral nematic mesophase.

*Notes:*

1. See Fig. 3 for an illustration of the helicoidal molecular distribution in a chiral nematic mesophase.
2. Locally, a chiral nematic mesophase is similar to a uniaxial nematic, except for the precession of the director  $\mathbf{n}$  about the axis,  $Z$ .
3. The director is periodic along  $Z$  with the pitch  $P$  of the helical structure equal to a turn of the local director  $\mathbf{n}$  by  $2\pi$ .
4. Chiral nematic mesophases exhibit Bragg scattering of circularly polarized light at a wavelength  $\lambda_R$  proportional to the pitch  $P$  ( $\lambda_R = \langle n \rangle P$ , where  $\langle n \rangle$  is the mean refractive index).
5. The director precession in a chiral nematic mesophase is spontaneous and should be distinguished from an induced twisted structure produced by a mechanical twist of a nematic mesophase between confining surfaces.
6. The term chiral nematic mesophase or chiral nematic is preferred to cholesteric or cholesteric mesophase.

**3.1.4 blue phase***Recommended abbreviation:* BP

A mesophase with a three-dimensional spatial distribution of helical director axes leading to frustrated structures with defects arranged on a lattice with cubic symmetry and lattice constants of the order of the wavelength of visible light.

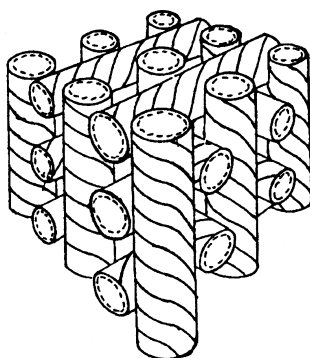

**Fig. 4** Illustrating a cubic lattice formed by double-twist cylinders as a possible model of a BP.

*Notes:*

1. See Fig. 4 for a possible model for a BP.
2. The name “blue phase” derives historically from the optical Bragg reflection of blue light but, because of larger lattice constants, BPs can reflect visible light of longer wavelengths.
3. With chiral nematic substances forming chiral nematic mesophases of short pitch ( $<700$  nm), up to three blue phases occur in a narrow temperature range between the chiral nematic phase and the isotropic phase.
4. A BP is optically isotropic and exhibits a Bragg reflection of circularly polarized light.
5. Two BPs of different cubic symmetry (space group  $I 4_132$  for BP I and  $P 4_232$  for BP II) are presently known, together with a third (BP III) of amorphous structure. Several other BPs of different cubic symmetry exist but only in the presence of external electric fields.

**3.1.5 smectic mesophase***Recommended abbreviation:* Sm

A mesophase that has the molecules arranged in layers with a well-defined layer spacing or periodicity.

*Notes:*

1. There are several types of smectic mesophases, characterized by a variety of molecular arrangements within the layers.
2. Although the total number of smectic mesophases cannot be specified, the following types have been defined: SmA, SmB, SmC, SmF, and SmI. The alphabetical order of suffixes merely indicates an order of discovery.
3. The classification of SmD as smectic is largely a consequence of history, and should be discontinued (see Definition 3.1.9).
4. At one time, a number of mesophases were identified as smectic on the basis of their optical textures, but they are in fact soft crystals characterized by very low yield stresses. Hence, these three-dimensionally ordered phases should no longer be called smectic mesophases. They are akin to plastic crystals with some elementary long-range order and are referred to by the letters E, J, G, H, K (see 3.1.5.3).
5. Tilted smectic mesophases formed by chiral compounds or containing chiral mixtures are designated by the superindex \* (SmC\*, SmF\*, etc.). (See, e.g., Definition 3.1.5.1.3.)

## 3.1.5.1 smectic mesophases with unstructured layers

## 3.1.5.1.1 smectic A mesophase

*Recommended abbreviation:* SmA

A smectic mesophase involving a parallel arrangement of the molecules within layers, in which the long axes of the molecules tend to be perpendicular; the layer planes and the molecular centers of mass have no long-range positional order parallel to the layer planes

*Notes:*

**Fig. 5** Illustrating the structure of a smectic A mesophase.

1. See Fig. 5 for the molecular organization in a smectic A mesophase.
2. Each layer approximates to a true two-dimensional liquid. The system is optically uniaxial, and the optic axis,  $Z$ , is normal to the layer planes.
3. The directions  $+Z$  and  $-Z$  are interchangeable.
4. The structure of a smectic A mesophase is characterized by the symbol  $D_{\infty h}$  in the Schoenflies notation ( $\infty, 2$  in the International System).
5. The lyotropic equivalent of a smectic A mesophase is known as a **lamellar mesophase**; where layers of amphiphilic molecules are separated by layers of solvent, normally water, or by oil in an **inverse lamellar mesophase**.
6. A smectic A-phase containing a chiral molecule or dopant, can be called a chiral smectic A-phase. The recommended symbol is SmA\* wherein the (\*) indicates that the macroscopic structure of the mesophase is chiral.

### 3.1.5.1.2 smectic C mesophase

*Recommended abbreviation:* SmC

The analog of a smectic A mesophase involving an approximately parallel arrangement of the molecules within layers in which the director is tilted with respect to the layer normal and the molecular centers-of-mass have no long-range positional order parallel to the layer planes (see Fig. 6).

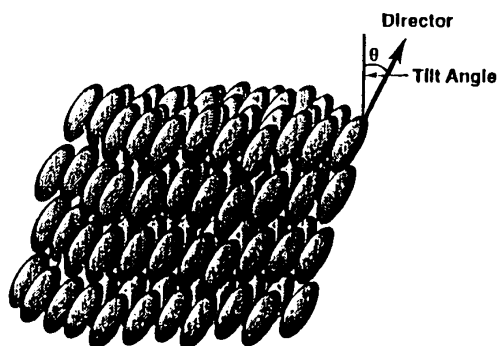

**Fig. 6** Illustrating the structure of the smectic C mesophase.

*Notes:*

1. See Fig. 6 for an illustration of the molecular organization in a smectic C mesophase.
2. The physical properties of a smectic C mesophase are those of a biaxial crystal.
3. The smectic C structure corresponds to monoclinic symmetry characterized by the symbol  $C_{2h}$ , in the Schoenflies notation and the space group  $t 2/m$  in the International System.
4. The tilt direction varies in a random manner from layer to layer in conventional smectic C mesophases. However, it can alternate from layer to layer, as in an **antiferro-electric chiral smectic C mesophase** (see Definition 5.9, Note 7) and in the smectic C mesophase formed by certain liquid crystal dimers with an odd number of carbon atoms in the spacers (see Definition 2.11.2.9). The recommended symbol for this type of mesophase is **SmCa**.

### 3.1.5.1.3 chiral smectic C mesophase

*Recommended abbreviation:* SmC\*

A smectic C mesophase in which the tilt direction of the director in each successive layer is rotated through a certain angle relative to the preceding one so that a helical structure of a constant pitch is formed.

*Notes:*

1. See Fig. 7 for an illustration of the molecular organization in a chiral smectic C mesophase.
2. The (\*) in SmC\* and analogous notations indicates, as in 3.1.5.1.2 (Note 6), that the macroscopic structure of the mesophase is chiral. However, it is also used simply to indicate that some of the constituent molecules are chiral even though the microscopic structure may not be.
3. A SmC\* mesophase is formed by chiral compounds or mixtures containing chiral compounds.
4. Locally, the structure of the chiral smectic C mesophase is essentially the same as that of the achi-ral smectic C mesophase except that there is a precession of the tilt direction about a single axis. It has the symmetry  $C_2$  in the Schoenflies notation.
5. This chiral smectic C phase is also known as the ferro-electric chiral smectic C phase.
6. The helix can be unwound by surface forces to give a surface-stabilized SmC\*, which has a macroscopic polarization.

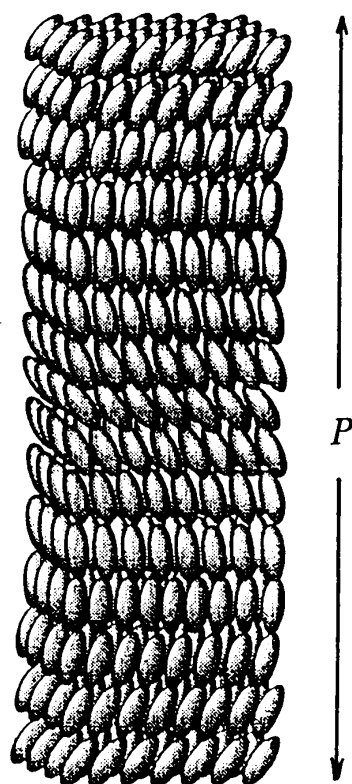

**Fig. 7** Illustrating the structure of a chiral smectic C mesophase ( $P$  = helical pitch).

### 3.1.5.2 hexatic smectic mesophase

A smectic mesophase with in-plane short-range positional molecular order, weakly coupled two-dimensional layers and long-range bond orientational molecular order.

*Note:* There are three types of hexatic smectic mesophases: smectic B (SmB), smectic F (SmF), and smectic I (SmI). Here, the term “hexatic” may be omitted because it is implicit for this group of smectic mesophases.

#### 3.1.5.2.1 smectic B mesophase

*Recommended abbreviation:* SmB

A hexatic smectic mesophase in which the director is perpendicular to the layers with the long-range hexagonal bond-orientational order.

*Notes:*

1. See Fig. 8 for an illustration of the molecular organization in a smectic B mesophase.
2. Positional molecular order does not propagate over distances larger than a few tens of nanometers but bond orientational molecular order extends over macroscopic distances within and across layers.
3. By contrast with a smectic B mesophase, a crystal B mesophase has correlations of positional order (hexagonal) in three dimensions, i.e., correlations of position occur within and between layers.
4. The structure of a smectic B mesophase is characterized by a  $D_{6h}$  point group symmetry, in the Schoenflies notation, by virtue of the bond orientational order.



5. A smectic B mesophase is optically uniaxial.
6. A smectic B mesophase is sometimes denoted  $\text{SmB}_{\text{hex}}$ . The subscript "hex" denotes the hexagonal structure of the mesophase.

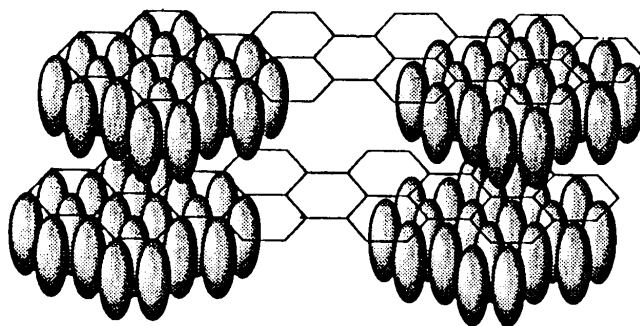

Fig. 8 Illustrating the structure of a smectic B mesophase.

#### 3.1.5.2.2 smectic F mesophase

*Recommended abbreviation:* SmF

A hexatic smectic mesophase the structure of which may be regarded as a C-centered monoclinic cell with a hexagonal packing of the molecules with the director tilted, with respect to the layer normals, toward the sides of the hexagons.

*Notes:*

1. See Fig. 9a for an illustration of the molecular organization in a smectic F mesophase, a tilted analog of the smectic B mesophase.
2. A SmF mesophase is characterized by in-plane short-range positional correlations and weak or no interlayer positional correlations.
3. Positional molecular order extends over a few tens of nanometers but the bond orientational molecular order is long-range within a layer.
4. The point-group symmetry is  $C_{2h} (2/m)$  in the Schoenflies notation, and the space group,  $t 2/m$  in the International System.
4. The smectic F mesophase is optically biaxial.
5. Chiral materials form **chiral smectic F mesophases** denoted by  $\text{SmF}^*$ .

#### 3.1.5.2.3 smectic I mesophase

*Recommended abbreviation:* SmI

A hexatic smectic mesophase the structure of which may be regarded as a C-centered monoclinic cell with hexagonal packing of the molecules with the director tilted, with respect to the layer normals, toward the apices of the hexagons.

*Notes:*

1. See Figs. 9a and 9b for illustrations of the molecular organizations of smectic F and I mesophases. They are tilted analogs of the smectic B mesophase.
2. The smectic I mesophase is optically biaxial.
3. The in-plane positional correlations in a smectic I mesophase are slightly greater than in a smectic F mesophase.
4. Chiral materials form **chiral smectic I mesophases** denoted by  $\text{SmI}^*$ .

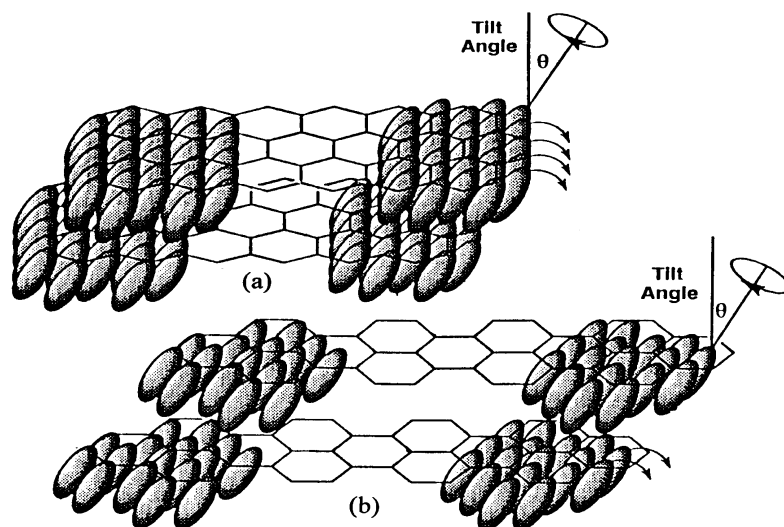

**Fig. 9** Illustrating the tilt directions of the director in (a) SmF and (b) SmI mesophases indicating, respectively, the tilt of the director towards the sides of the hexagons (a) and the apices of the hexagons (b).

### 3.1.5.3 crystal B, E, G, H, J, and K mesophases

Soft crystals that exhibit long-range positional molecular order, with three-dimensional stacks of layers correlated with each other.

*Notes:*

1. Originally, these mesophases were designated as smectic, but further investigations have demonstrated their three-dimensional character.
2. In the crystal B and E mesophases, the molecular long axes are essentially parallel to the normals to the layer planes, while in the G, H, J, and K mesophases they are tilted with respect to the layer normals.
3. The E, J, and K phases have herringbone organizations of the molecular short axes, and so the mesophases are optically biaxial.

### 3.1.6 polymorphic modifications of strongly polar compounds

#### 3.1.6.1 re-entrant mesophase

*Recommended subscript: re*

The lowest temperature mesophase of certain compounds that exhibit two or more mesophases of the same type, over different temperature ranges.

*Notes:*

1. Re-entrant mesophases are most commonly observed when the molecules have strong longitudinal dipole moments (see example).
2. Sequences of re-entrant mesophases have also been found in binary mixtures of nonpolar liquid-crystalline compounds.

*Example:* The following compound exhibits, as temperature decreases, an isotropic (I) phase, nematic (N), smectic A (SmA) re-entrant nematic ( $N_{re}$ ), re-entrant smectic A ( $SmA_{re}$ ) mesophases, and a crystalline (Cr) phase, with transitions at the specified temperatures.

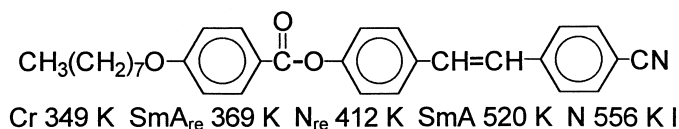

3.1.6.2 smectic  $A_1$ ,  $A_2$ ,  $A_d$ ,  $C_1$ ,  $C_2$ , and  $C_d$ 

*Recommended abbreviations:*  $SmA_1$ ,  $SmA_2$ ,  $SmA_d$ ,  $SmC_1$ ,  $SmC_2$ ,  $SmC_d$

Smectic A and smectic C mesophases characterized by antiparallel ( $SmA_2$ ,  $SmA_d$ , and  $SmC_2$ ,  $SmC_d$ ) and random ( $SmA_1$  and  $SmC_1$ ) alignments of the molecular dipoles within the layer thickness in Fig. 10.

*Notes:*

1. See Figs. 10 and 11 for illustrations of the molecular arrangements in the mesophases.
2. The subscripts 1,  $d$ , and 2 indicate that the layer thickness is one,  $d$ , and two times the fully extended molecular length, with  $1 < d < 2$ .
3.  $SmA_d$  and  $SmC_d$  mesophases form bilayers with partial overlapping of the molecules of adjacent layers.
4.  $SmA_2$  and  $SmC_2$  phases form bilayers with antiparallel ordering of the molecules.
5. Bilayer structures are also known for SmB and crystal E mesophases.

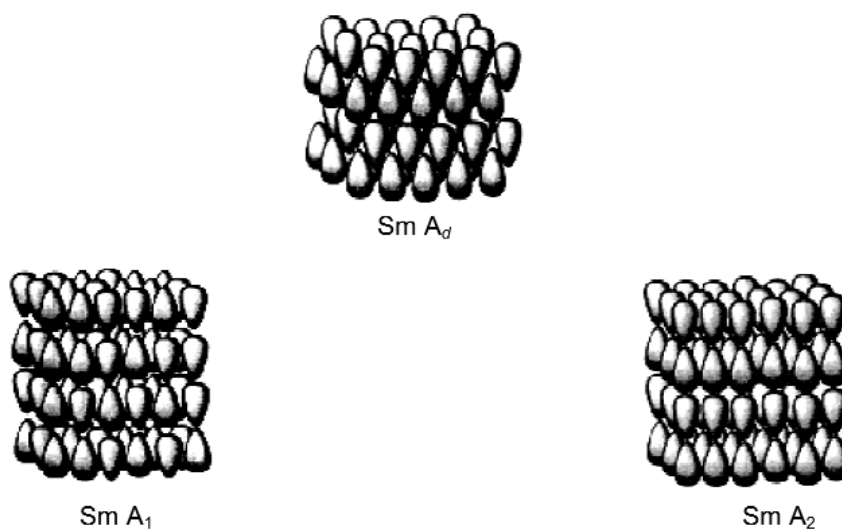

**Fig. 10** Illustrating the molecular structures of  $SmA_d$ ,  $SmA_1$ , and  $SmA_2$  mesophases.

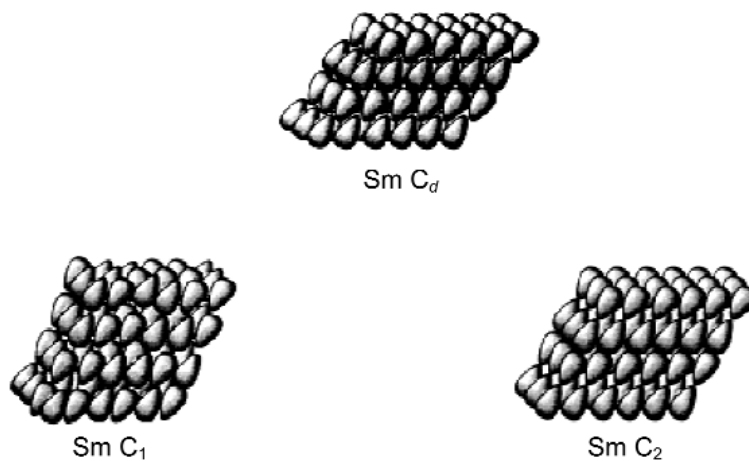

**Fig. 11** Illustrating the molecular structures of  $SmC_d$ ,  $SmC_1$ , and  $SmC_2$  mesophases.

## 3.1.6.3 modulated smectic mesophase

*Recommended mark:* ~

A smectic mesophase that has a periodic in-plane density variation.

*Notes:*

1. See Figs. 12a and 12b for illustrations of the molecular arrangements in
2. The  $\text{Sm}\tilde{\text{A}}$  mesophase is also known as a **centered rectangular mesophase** or **antimesophase**. The dimensional space group is *cmm* in the International System.
3. The  $\text{Sm}\tilde{\text{C}}$  mesophase is also known as an **oblique** or **ribbon mesophase**. The dimensional space group is *pmg* in the International System.

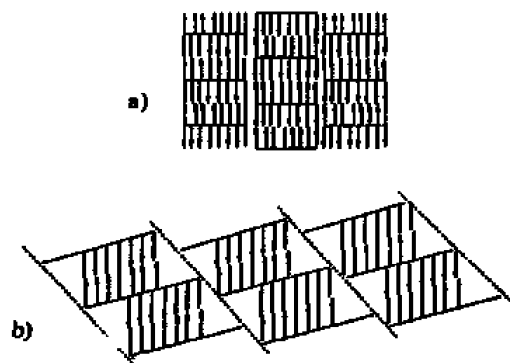

**Fig. 12** Schematic drawing of the modulated smectic mesophases (a)  $\text{Sm}\tilde{\text{A}}$  and (b)  $\text{Sm}\tilde{\text{C}}$ .

## 3.1.7 intercalated smectic mesophase

*Recommended subscript:* *c*

A smectic mesophase is a mesophase that has a spacing between layers (smectic periodicity) of approximately one-half of the molecular length.

*Notes:*

1. Intercalated smectic mesophases are commonly observed for liquid-crystal dimers.
2. At present intercalated smectic A ( $\text{SmA}_c$ ) and smectic C ( $\text{SmC}_c$ ) as well as intercalated crystal B ( $\text{B}_c$ ), G ( $\text{G}_c$ ), and J ( $\text{J}_c$ ) mesophases have been observed.
3. The local structure in the nematic mesophase of certain dimers exhibit an intercalated smectic mesophase.

## 3.1.8 induced mesophase

A particular mesophase formed by a binary mixture, the components of which do not separately form mesophases, with the particular mesophase existing above the melting points of both components.

*Notes:*

1. The formation of an induced mesophase usually results from an attractive interaction between unlike species, the strength of which exceeds the mean of the strengths of the interactions between like species.
2. Examples of such interactions that have been noted are dipolar/nonpolar, charge-transfer, and quadrupolar.
3. Mesophases can also be induced when the free-volume between the large, irregular molecules of one component is filled by the smaller molecules of the second component. Such mesophases have been called filled smectic mesophases, although the term “induced” is recommended.
4. A monotropic mesophase can be stabilized in a mixture when, as a result of melting-point depression, a metastable mesophase becomes stabilized. Such a mesophase is distinct from an induced mesophase.

### 3.1.9 cubic mesophase

*Recommended abbreviation:* Cub

A mesophase with an overall three-dimensional order of cubic symmetry in which each micellar unit cell contains several hundred molecules in random configurations, as in a liquid.

*Notes:*

1. The mesophase formerly designated as smectic D (see Definition 3.1.5, Note 3) belongs to this class.
2. A cubic mesophase is optically isotropic; it may be distinguished from an isotropic liquid or a homeotropic phase by the fact that the optically black isotropic phase or homeotropic phase nucleates in the birefringent SmC phase in straight-edged squares, rhombi, hexagons, and rectangles.
3. A cubic mesophase may be formed by rod-like molecules with strong, specific intermolecular interactions, such as hydrogen bonding, between them. However, they are also found in polycatenary compounds (see Definition 2.11.2.5) where there are no specific, strong interactions.
4. Cubic mesophases have long been known in thermotropic salt-like compounds and in lyotropic liquid-crystals.
5. There are several types of thermotropic and lyotropic cubic mesophases, with different symmetry and miscibility properties; when the space groups of these are known, they should be included in parentheses after the term "Cub".

*Example:* The following compound exhibits a crystalline phase (Cr), smectic SmC, cubic (Cub), smectic SmA mesophases, and an isotropic (I) phase, with transitions at the specified temperatures:

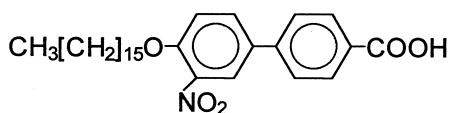

Cr 399.95 K SmC 444.15 K Cub 471.65 K SmA 472.15 K I

## 3.2 mesophases of disc-like mesogens

### discotic mesophases

#### discotics

#### 3.2.1 discotic nematic mesophase

##### discotic nematic

*Recommended symbol:* N

A nematic mesophase in which disc-shaped molecules, or the disc-shaped portions of macromolecules, tend to align with their symmetry axes parallel to each other and have a random spatial distribution of their centers of mass.

*Notes:*

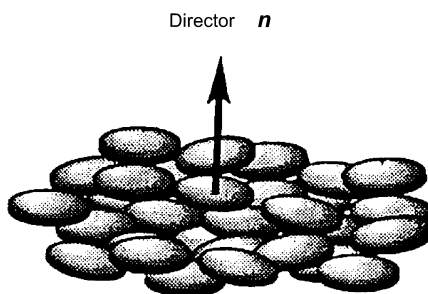

**Fig. 13** Illustrating the organization of molecules in a discotic nematic mesophase.

1. See Fig. 13 for an illustration of the molecular arrangement in a discotic mesophase.
2. The symmetry and structure of a nematic mesophase formed from disc-like molecules is identical to that formed from rod-like molecules. It is recommended therefore, that the subscript “D” is removed from the symbol “ $N_D$ ”, often used to denote a nematic formed from disc-like molecules.
3. In some cases, the discotic nematic mesophase is formed by compounds that do not have molecules of discotic shape (for example, phasmidic compounds, salt-like materials, and oligosaccharides).
4. Chiral discotic nematic mesophases,  $N^*$ , also exist.

3.2.2 *columnar mesophase*  
*columnar discotic mesophase*  
*columnar discotic*  
*Recommended abbreviation: Col*

A mesophase in which disc-shaped molecules, the disc-shaped moieties of macromolecules, or wedge-shaped molecules assemble themselves in columns packed parallel on a two-dimensional lattice, but without long-range positional correlations along the columns.

*Note:* Depending on the order in the molecular stacking in the columns and the two-dimensional lattice symmetry of the columnar packing, the columnar mesophases may be classified into three major classes: hexagonal, rectangular, and oblique (see Definitions 3.2.2.1 to 3.2.2.3).

3.2.2.1 *columnar hexagonal mesophase*  
*Recommended abbreviation: Col<sub>h</sub>*

A columnar mesophase characterized by a hexagonal packing of the molecular columns.

*Notes:*

1. See Fig. 14 for an illustration of the molecular arrangement in a Col<sub>h</sub> mesophase.
2. Hexagonal mesophases are often denoted Col<sub>ho</sub> or Col<sub>hd</sub> where h stands for hexagonal and o and d refer to the range of positional correlations along the column axes: o stands for ordered and d for disordered. The use of the subscripts o and d should be discontinued. In both cases, the ordering is liquid-like; only the correlation lengths are different.
3. The relevant space group of a Col<sub>h</sub> mesophase is P 6/mmm (equivalent to P 6/m 2/m in the International System and point group D<sub>6h</sub> in the Schoenflies notation).
4. The lyotropic equivalent of a columnar hexagonal mesophase is known as a **hexagonal mesophase**; in it, columns of amphiphilic molecules are surrounded by the solvent, normally water, or an oil in an **inverse hexagonal mesophase**.

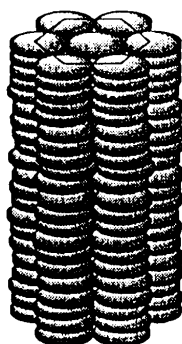

**Fig. 14** Illustrating the molecular organization of a columnar hexagonal mesophase.

## 3.2.2.2 columnar rectangular mesophase

*Recommended symbol:* Col<sub>r</sub>

A columnar mesophase characterized by a liquid-like molecular order along the columns, in which the columns are arranged in a rectangular packing.

*Notes:*

1. See Figs. 15a–c for illustrations of molecular arrangements in columnar rectangular mesophases.
2. The average orientation of the planes of the molecular discs is not necessarily normal to the column axes.
3. Depending on the plane space-group symmetries, three rectangular mesophases are distinguished (see Figs. 15a–c).
4. There also exist chiral columnar rectangular mesophases, with the molecular discs tilted periodically in the columns and with the tilt directions changing regularly down the columns.

## 3.2.2.3 columnar oblique mesophase

*Recommended symbol:* Col<sub>ob</sub>

A columnar mesophase characterized by a liquid-like molecular order along the column, in which the columns are arranged with an oblique packing.

*Notes:*

1. See Fig. 15d for an illustration of the molecular arrangement in a columnar oblique mesophase.
2. The average of the planes of the molecular discs is not necessarily normal to the columnar axes.
3. The plane space-group symmetry of a Col<sub>ob</sub> mesophase is P<sub>1</sub> (see Fig. 15d).
4. There also exist **chiral columnar oblique mesophases**, with the tilt directions of the columnar discs varying regularly along the columns.

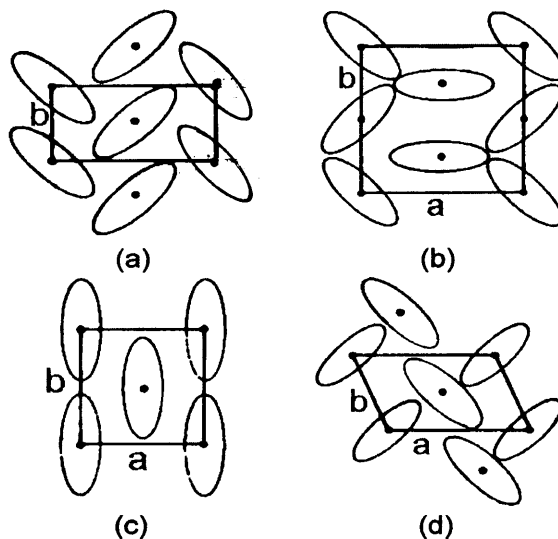

**Fig. 15** Plan views of the two-dimensional lattice of the columns in columnar rectangular (a) to (c) and oblique (d) mesophases. Ovals indicate the planes of the molecular discs. Plane space group symmetries in the projection of the International System are: (a) - P<sub>2</sub><sub>1</sub>/a; (b) - P<sub>2</sub>/a and (c) - C<sub>2</sub>/m (d) - P<sub>1</sub>.

## 3.3 biaxial mesophase

*Recommended subscript:* b

A mesophase composed of board-like molecules in which there are long-range orderings of both the longer and the shorter molecular axes.

*Notes:*

1. A biaxial mesophase has three orthogonal directors denoted by the unit vectors  $\mathbf{l}$ ,  $\mathbf{m}$ , and  $\mathbf{n}$ .
2. The tensorial properties of a biaxial mesophase have biaxial symmetry unlike the uniaxial symmetries of, for example, the nematic and smectic A mesophases.
3. The biaxiality of the phase does not result from tilted structures as, for example, in a smectic C mesophase.
4. Distinct biaxial mesophases are created when the molecular centers of mass are correlated within the layers. Such mesophases have been proposed for board-like polymers and have been called sanidic mesophases (see Definitions 3.4, 3.4.1, and 3.4.2).
5. Sanidic structures are analogous to the columnar mesophases formed by disc-like molecules (see Definition 3.2.2).

**3.3.1** *biaxial nematic mesophase**biaxial nematic**Recommended symbol:*  $N_b$ 

A mesophase in which the long axes of the molecules are, on average, orientationally ordered about a common director and one of the shorter molecular axes is ordered, on average, about a second, orthogonal director.

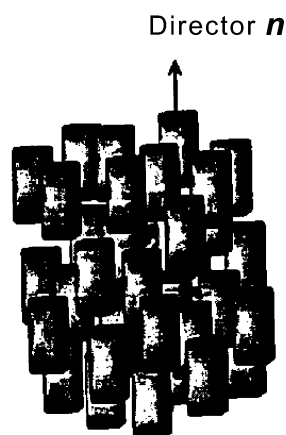

**Fig. 16** Schematic representation of a biaxial nematic mesophase.

*Notes:*

1. See Fig. 16 for an illustration of the molecular arrangement in a  $N_b$  mesophase.
2. From a crystallographic point of view, the biaxial nematic structure is characterized by the symbol  $D_{2h}$  in the Schoenflies notation ( $2/m$ ,  $m$  in the International System).
3. In lyotropic systems, biaxial nematic mesophases have been identified from the biaxial symmetry of their tensorial properties.
4. The situation for thermotropic calamitic systems is less clear and for some compounds claimed to form a  $N_b$ , detailed investigations have found the mesophase to be of type  $N_u$  (see Definition 3.1.1).
5. A biaxial nematic has the same structure as a disordered sanidic mesophase (see Definition 3.4, Note 2); it is recommended that the latter name be discontinued and the name biaxial nematic be used.



### 3.3.2 *biaxial smectic A mesophase*

**Recommended symbol:**  $\text{SmA}_b$

A smectic A mesophase composed of board-like molecules with the longer and the shorter molecular axes orientationally ordered.

*Note:* For a  $\text{SmA}_b$  mesophase, the molecular centers-of-mass have only short-range positional order within a layer.

## 3.4 **sanidic mesophase**

**Recommended symbol:**  $\Sigma$

A mesophase in which board-shaped molecules assemble in stacks packed parallel to one another on a one- or two-dimensional lattice (see Figs. 17 and 18).

*Notes:*

1. See Figs. 17 and 18 for examples of sanidic mesophases.
2. Short board-like shaped molecules usually form biaxial nematic mesophases. It is recommended that the use of the term “disordered sanidic mesophases” for such mesophases be discontinued (see Definition 3.3.1, Note 5).
3. Rotation of the molecules around their long axes is considerably hindered.

### 3.4.1 *rectangular sanidic mesophase*

**Recommended symbol:**  $\Sigma_r$

A sanidic mesophase in which the molecular stacks are packed regularly side-by-side with long-range order along a stack normal as well as along the long stack-axis.

*Note:* See Fig. 17 for an illustration of the molecular arrangement in a  $\Sigma_r$  mesophase.

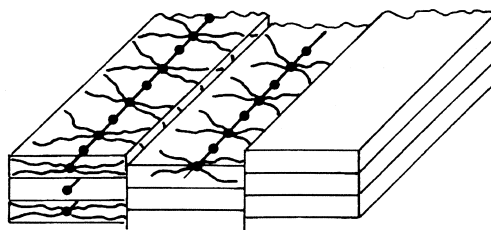

**Fig. 17** Illustrating a rectangular sanidic mesophase.

### 3.4.2 *ordered sanidic mesophase*

**Recommended symbol:**  $\Sigma_o$

A mesophase in which the molecular stacks are packed regularly side-by-side with long-range order along a stack normal and no registration along the long stack-axis.

*Note:* See Fig. 18 for an illustration of the molecular arrangement in a  $\Sigma_o$  mesophase.

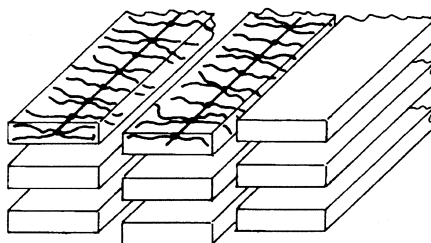

**Fig. 18** Illustrating an ordered sanidic mesophase.

### 3.5 glassy mesophase

**Recommended subscript: g**

A mesophase in which nonvibratory molecular motion is frozen by supercooling a mesophase stable at a higher temperature.

### 3.6 twist grain-boundary mesophase

**Recommended abbreviation: TGB**

A defect-stabilized mesophase created when a smectic A mesophase is subjected to a twist or bend distortion.

*Notes:*

1. The twist and bend distortions can be stabilized by an array of screw or edge dislocations.
2. A TGB mesophase is analogous to the Abrikosov flux-phase of certain superconductors.

#### 3.6.1 twist grain-boundary A\* mesophase

**Recommended abbreviation: TGBA\***

A mesophase with a helicoidal supramolecular structure in which blocks of molecules, with a local structure of the smectic A type, have their layer normals rotated with respect to each other and are separated by screw dislocations.

*Notes:*

1. See Fig. 19 for an illustration of the molecular arrangement of a TGBA\* mesophase.
2. The TGBA\* mesophase is formed by a chiral compound or a mixture of chiral compounds.
3. Two TGBA\* structures are possible; in one, the number of blocks corresponding to a rotation of the layer normal by  $2\pi$  is an integer, while in the other, it is a noninteger.
4. A TGBA\* is found in a phase diagram between smectic A and chiral nematic mesophases or between a smectic A mesophase and an isotropic phase.
5. The temperature range of existence of a TGBA\* mesophase is typically several K.

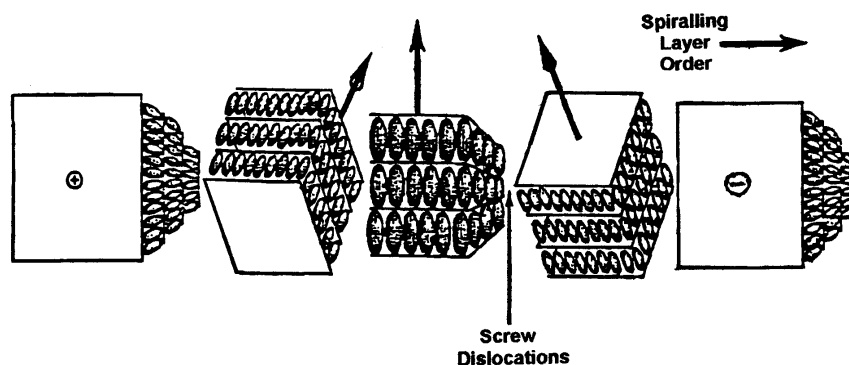

**Fig. 19** Illustrating the structure of a TGBA\* mesophase corresponding to half of the full helical twist.

#### 3.6.2 twist grain-boundary C\* mesophase

**Recommended abbreviation: TGBC\***

A mesophase of helicoidal supermolecular structure in which blocks of molecules with a local structure of the smectic C type, have their layer normals rotated with respect to each other and are separated by screw dislocations.

*Notes:*

1. Two forms of TGBC\* mesophase are possible: in one form the director within the layer is tilted and rotates coherently through the layers in a block as in a chiral smectic C mesophase, while in

the other form the director within a block is simply tilted with respect to the layer normal as in a smectic C mesophase.

- In the case of a short pitch, when  $P$  is less than the wavelength  $\lambda$ , the macroscopic extraordinary axis for the refractive index is orthogonal to the director.

### 3.6.3 *melted-grain-boundary mesophase* *Recommended abbreviation: MGBC\**

A mesophase with a helicoidal supramolecular structure of blocks of molecules with a local smectic C structure. The layer normal to the blocks rotates on a cone to create a helix-like director in the smectic C\*. The blocks are separated by plane boundaries perpendicular to the helical axis. At the boundary, the smectic order disappears but the nematic order is maintained. In the blocks the director rotates from one boundary to the other to allow the rotation of the blocks without any discontinuity in the thermo-orientation.

*Note:* This phase appears between the TGBA and SmC\* or N\* and SmC\* mesophases.

## 4. TEXTURES AND DEFECTS

### 4.1 domain

A region of a mesophase having a single director.

*Note:* See 3.1.1.1 for the definition of a director.

### 4.2 monodomain

A region of a uniaxial mesophase or a whole uniaxial mesophase having a single director or a region of a biaxial mesophase or a whole biaxial mesophase having two directors.

*Notes:*

- See 3.1.1 for the definition of a uniaxial nematic mesophase, 5.8.1 for the definition of uniaxial mesophase anisotropy, and Definitions 3.3 and 5.8.2 relating to biaxial mesophases.
- For a smectic mesophase, the term “monodomain” also implies a uniform arrangement of the smectic layers.

### 4.3 homeotropic alignment

A molecular alignment of which the director is perpendicular to a substrate surface.

*Notes:*

- See Fig. 20a.
- When the alignment of the director in a homeotropic alignment deviates from the perpendicular, the alignment is said to be a **pretilted homeotropic alignment**; the pretilt angle is the deviation from  $90^\circ$ .
- Surface pretilt** is the deviation angle of the director away from the surface. It is used to control the threshold voltage and affects viewing angles.

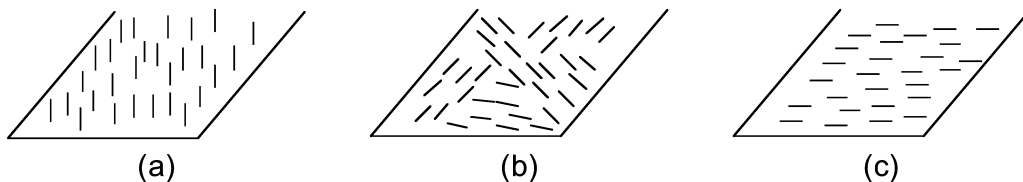

**Fig. 20** Representing (a) homeotropic, (b) planar, and (c) uniform planar molecular alignments.

#### 4.4 planar alignment homogeneous alignment

A molecular alignment in which directors lie parallel to a substrate surface.

*Note:* See Fig. 20b.

#### 4.5 uniform planar alignment

A molecular alignment in which the director is parallel to a substrate surface.

*Notes:*

1. See Fig. 20c.
2. Sometimes a uniform planar alignment is called a “uniform homogeneous alignment”. The latter term is not recommended.

#### 4.6 twist alignment

A molecular alignment for which the director rotates in a helical fashion when passing between two substrate surfaces having molecules in uniform planar alignments.

*Notes:*

1. See Fig. 21. The length of a line in Fig. 21 indicates the length of a director projected onto the plane of the page.
2. The orientation of the directors on the upper and lower substrate surfaces are usually mutually orthogonal, and hence the directors undergo a  $90^\circ$  twist over the thickness of the liquid-crystal layer.

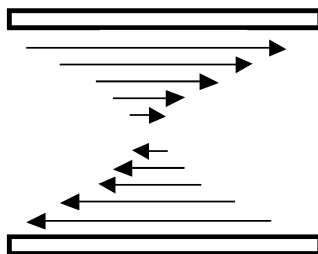

**Fig. 21** Illustrating a twist alignment.

#### 4.7 defect

A nonuniform molecular alignment that cannot be transformed into a uniform alignment without creating other defects.

*Notes:*

1. Dislocations and disclinations are major types of defects in liquid crystals.
2. Three elementary types of defects may be distinguished in liquid crystals. They are point, line, and wall defects.
3. A discontinuity in the structure (or in the mathematical function describing the structure) is considered as a singularity; in many cases, a defect can be regarded as a singularity.

##### 4.7.1 dislocation

A discontinuity in a regular molecular positional arrangement.

*Note:* Dislocations are found mainly in solid crystals.

#### 4.7.2 *disclination*

A defect along a line in the regular orientation of directors.

*Notes:*

1. Disclinations are responsible for some optical textures seen with a polarizing microscope, such as the schlieren texture formed by disclination lines in nearly vertical orientations, whose projections are seen as dark points with two or four emerging dark stripes or brushes (see Definition 4.9.2).
2. Disclinations are defects in molecular orientational order in contrast to dislocations that are defects in molecular positional order.

### 4.8 **optical texture**

An image of a liquid-crystal sample seen with a microscope, usually with crossed polarizers.

*Note:* An optical texture results from surface orientation of the directors at the boundaries of the sample and by defects formed in the sample.

### 4.9 **nematic textures**

#### 4.9.1 *nematic droplet*

A spherical droplet that forms during a transition from an isotropic phase to a nematic mesophase. It has characteristic textures that depend on the droplet size and the director orientation at the nematic-isotropic interface.

*Note:* Nematic droplets display a texture characteristic of a nematic mesophase since they occur nowhere else.

##### 4.9.1.1 bipolar droplet texture

A texture with two point defects at the poles of a nematic droplet.

*Notes:*

1. A pole is the position of the extreme of a director in a droplet.
2. The point defects are called **boojums**.
3. A bipolar droplet texture occurs when the director lies in the plane of a nematic-isotropic interface.

##### 4.9.1.2 radial droplet texture

A texture with one point defect at the center of a nematic droplet.

*Notes:*

1. The point defect usually forms when the director is normal to the nematic-isotropic interface.
2. The radial droplet texture shows four dark brushes located in the regions where the director is in the polarization plane of either the polarizer or the analyzer.

#### 4.9.2 *schlieren texture*

A texture observed for a flat sample between crossed polarizers, showing a network of black brushes connecting centers of point and line defects.

*Notes:*

1. The black brushes are also called black stripes or schlieren brushes.
2. Black brushes are located in regions where the director lies in the plane of polarization of either the polarizer or the analyser.
3. Schlieren textures observed in nematic samples with planar alignment show defect centers with two or four emerging brushes. Schlieren textures in nematic samples with tilted alignments show centers with four brushes; centers with two brushes are caused by defect walls.
4. A thin sample of a smectic C phase with the layers parallel to the sample surfaces gives schlieren textures with centers that have four brushes. However, a smectic C phase formed by **odd-mem-**

**bered liquid-crystal dimers** (see Definition 2.11.2.9, Note 5) has schlieren textures with two or four brushes.

#### 4.9.2.1 nucleus

The center of a point or line defect from which black brushes originate when a liquid crystal is observed between crossed polarizers.

*Note:* A nucleus can indicate either the end of a disclination line terminating at the surface of a sample or an isolated defect.

#### 4.9.2.2 disclination strength

*Recommended symbol:*  $s$

The number of rotations by  $2\pi$  of the director around the center of the defect.

$$|s| = \frac{\text{number of brushes}}{4}$$

*Notes:*

1.  $s$  is positive when the brushes turn in the same direction as the polarizer and analyzer when they are rotated together, and negative when they turn in the opposite direction.
2.  $s$  can be an integer or half-integer since in nematics the directors  $+\mathbf{n}$  and  $-\mathbf{n}$  are not distinguishable.
3. The angular distribution  $\phi$  of the director around a defect in a nematic planar texture, in the X-Y projection, can be expressed in terms of the polar angle  $\theta_r$

$$\phi = s\theta_r + \phi_o$$

where  $\theta_r$  represents the angular polar coordinate of a given point with respect to the disclination center,  $\phi$  is the angle that the local director axis at that point makes with the  $\theta_r = 0$  axis, and  $\phi_o$  is a constant ( $0 < \phi_o < 2\pi$ ) (See Fig. 22).

The product  $s\theta_r$  yields the angle by which the director turns on a closed curve around the disclination center. If a complete circuit is made around the center of an  $s = \pm 1/2$  disclination, the director rotates by  $\pi$ . For  $s = \pm 1$  a similar circuit yields a total director rotation of  $2\pi$ . So,  $s = \pm 1/2$  defines a  $\pi$ -line disclination and  $s = \pm 1$  defines a  $2\pi$ -line disclination.

4. Director alignments for point defects with different values of  $s$  are illustrated in Fig. 23.

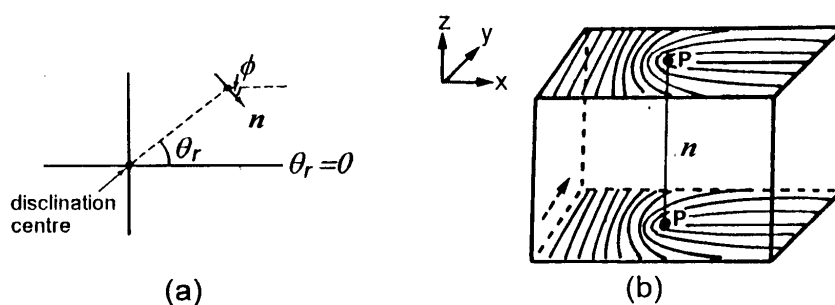

**Fig. 22** (a) Identification of the angles  $\phi$  and  $\theta_r$ , used to describe a disclination. (b) Director arrangement of an  $s = +1/2$  singularity line. The end of the line attached to the sample surface appears as the point  $s = +1/2$  (Points P). The director alignment or field does not change along the  $z$  direction. The director field has been drawn in the upper and the lower surfaces only.

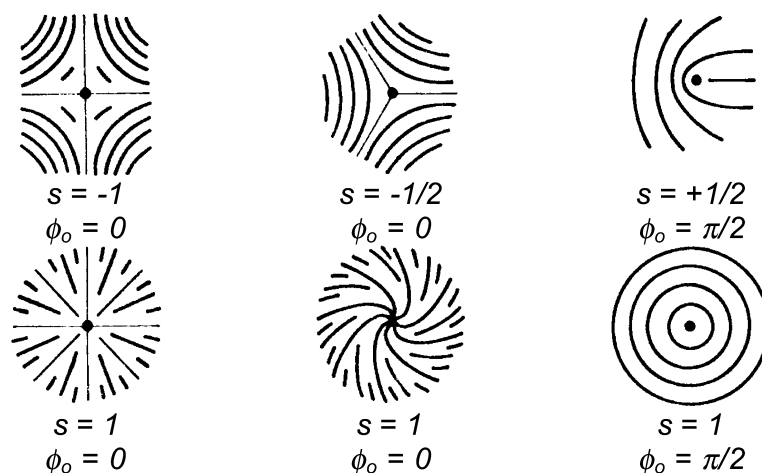

**Fig. 23** Schematic representation of the director alignments at disclinations with different values of  $s$  and  $\phi_0$ ;  $s = \pm 1/2$  correspond to two-brush defects and  $s = \pm 1$  to four-brush defects.

#### 4.9.3 threaded texture

A texture with  $\pi$ -line disclinations which lie essentially parallel to the surfaces between which a sample is placed, with the ends of the lines attached to the surfaces and the other parts of the lines moving freely in the liquid crystal, appearing as thin thread-like lines.

##### 4.9.3.1 surface disclination line adhering thread

A thick, thread-like disclination line anchored along its length to the upper or the lower of the surfaces between which a sample is placed.

#### 4.9.4 marbled texture

A texture consisting of several areas with different director orientations.

*Note:* On observing a sample with a marbled texture between crossed polarizers, the interference color is essentially uniform within each individual area, indicating an essentially homogeneous region.

### 4.10 smectic textures

#### 4.10.1 bâtonnet

A droplet, usually nonspherical, of a smectic phase nucleating from an isotropic phase.

#### 4.10.2 focal-conic domain

A domain formed by deformed smectic layers that fold around two confocal line defects preserving equidistance of structural layers everywhere except in the vicinity of the defect lines.

*Notes:*

1. See Fig. 24. The confocal line defects may be an ellipse and a hyperbola or two parabolae.
2. The smectic layers within a focal-conic domain adopt the arrangement of Dupin cyclides, since as in these figures there appear concentric circles resulting from the intersection of ellipses and hyperbolae. They also have the distinctive property of preserving an equal distance between them.
3. A focal-conic domain built around an ellipse and a hyperbola is the most common type of defect in thermotropic smectic A phases. The hyperbola passes through a focus of the ellipse and the ellipse passes through the focus of the hyperbola (see Fig. 24).
4. In a particular limiting case of an ellipse-hyperbola focal-conic domain, the ellipse becomes a straight line passing through the center of a circle.

5. A focal-conic domain built around two confocal parabolae is called a **parabolic focal-conic domain**.
6. At any point inside a focal-conic domain, the director is oriented along the straight line drawn through the point and the two defect lines (ellipse and hyperbola or two parabolae or circle and straight line). See for examples BD, BC, and BO in Fig. 24.

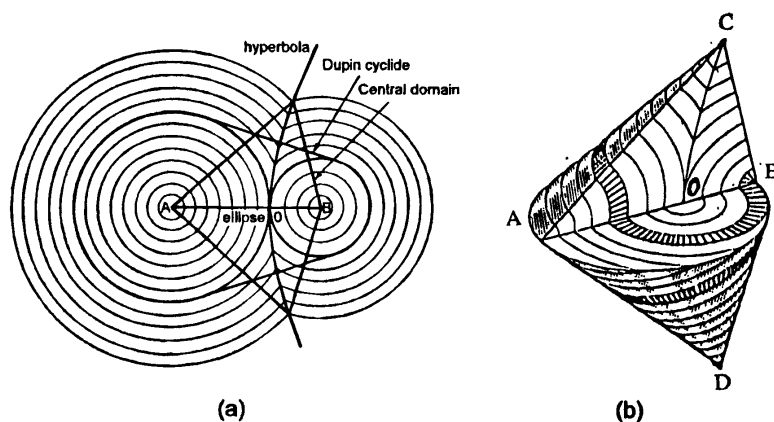

**Fig. 24** Dupin cyclide and perfect focal-conic domain construction: (a) vertical section showing layers of the structure; thick lines indicate the ellipse, hyperbola, Dupin cyclide, and central domain; (b) focal-conic domain showing structural layers with a representation of the arrangement of the molecules within one of them.

#### 4.10.3 polygonal texture

A texture composed of focal-conic domains of the ellipse-hyperbola type with visible ellipses, or parts of ellipses, located at the boundary surfaces.

*Notes:*

1. See Figs. 25a and 25b.
2. One branch of the hyperbola (either above or below the plane of the ellipse) is usually missing in the polygonal texture.
3. Neighboring domains form a family with a common apex where the hyperbolae of these domains join each other. This common point is located at the surface that is opposite to the surface containing the ellipses (see Fig. 26). Each family is bounded by a polygon formed by hyperbolic and elliptical axes; these are parts of focal-conic domains that provide a smooth variation of smectic layers between the domains of different families. These domains are the tetrahedra in Fig. 26.
4. The smectic layers pass continuously from one focal-conic to the next.

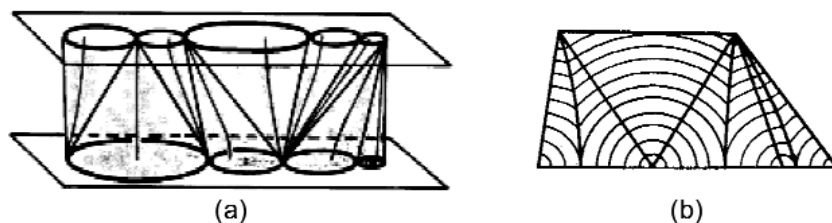

**Fig. 25** Arrangement of a smectic A polygonal texture: (a) general view of the focal-conic domains filling space efficiently; (b) cross-section of the domains showing arrangement of the smectic layers.



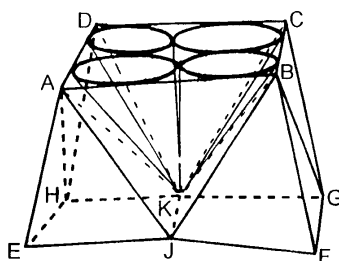

**Fig. 26** Elements of a smectic A complex polygonal texture. Upper surface: one polygon with four ellipses. Lower surface: two polygons. The whole space may be divided into three pyramids (ABCDK, AEHKJ, BFGKJ) and three tetrahedra (ABJK, ADHK, BCGK).

#### 4.10.4 focal-conic, fan-shaped texture

A texture formed partly by focal-conic domains with their hyperbolae lying in the plane of observation.

Notes:

1. See Fig. 27.
2. The layers are aligned almost normal to the sample surfaces. The regular sets of hyperbolae are called “**boundaries of Grandjean**”; they serve as limiting surfaces between domains with different director orientations.

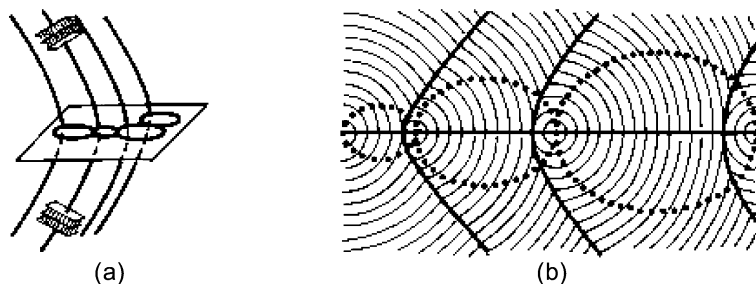

**Fig. 27** (a) Illustrating an arrangement of confocal ellipses and hyperbolae. The directors become parallel near the extremes of the hyperbolae. (b) Section showing the layer structure. The dotted ellipses in the plane of the drawing are sections perpendicular to the focal-conics.

## 5. PHYSICAL CHARACTERISTICS OF LIQUID CRYSTALS

*General Note:* In this section the director  $\mathbf{n}$  is treated mathematically as a unit vector, with components  $n_1, n_2, n_3$  along space-fixed axes  $X_1, X_2, X_3$ .

### 5.1 order parameter

**Recommended symbol:**  $\langle P_2 \rangle$

A parameter characterizing the long-range orientational order with reference to the director, with

$$\langle P_2 \rangle = (3 \langle \cos^2 \beta \rangle - 1) / 2$$

where  $\beta$  is the angle between the molecular symmetry axis and the director and  $\langle \rangle$  denotes an ensemble average.

Notes:

1.  $\langle P_2 \rangle$  characterizes long-range molecular order.
2. For rod-like molecules, the order parameter of the effective molecular symmetry axis at the nematic-isotropic transition is about 0.3 and can increase to about 0.7 in the nematic mesophase.
3. Molecules which constitute nematogens are not strictly cylindrically symmetric and have their orientational order given by the Saupe ordering matrix which has elements  $S_{\alpha\beta} = (3\langle \alpha|\beta \rangle - \delta_{\alpha\beta})/2$ , where  $|\alpha$  and  $|\beta$  are the direction cosines between the director and the molecular axes  $\alpha$  and  $\beta$ ,  $\delta_{\alpha\beta}$  is the Kroenecker delta, and  $\alpha, \beta$  denote the molecular axes X, Y, Z.
4. The constituent molecules of a nematogen are rarely rigid, and their orientational order is strictly defined, at the second-rank level, by a Saupe ordering matrix for each rigid subunit.
5. Even for molecules with cylindrical symmetry,  $\langle P_2 \rangle$  does not provide a complete description of the orientational order. Such a description requires the singlet orientational distribution function, which can be represented as an expansion in a basis of Legendre polynomials  $P_L \cos\beta$ , with  $L$  an even integer. The expansion coefficients are proportional to the order parameters  $\langle P_L \rangle$  of the same rank. It is these order parameters that provide a complete description of the long-range orientational order.

## 5.2 distortion in liquid crystals

**Recommended symbol:**  $a$

A deformation leading to a change in the director, where the distortion is described by a tensor of third rank

$$a_{3ij} = n_3 (\partial n_i / \partial x_j)$$

in which the initial orientation of the director  $\mathbf{n}$  is chosen as the 3-axis;  $i = 1, 2; j = 1, 2, 3; n_3 = 1, n_i$  is the  $i$ th component of the director  $\mathbf{n}$ , and  $x_j$  is a coordinate on axis  $X_j$ .

### 5.2.1 splay deformation

**Recommended abbreviation:** S-deformation

Deformation in a direction normal to the initial director,  $\mathbf{n}$ , characterized by  $\text{div } \mathbf{n} \neq 0$ .

Notes:

1. See Fig. 28 and Definition 5.3.
2. A splay deformation is described by the nonzero derivatives  $n_3(\partial n_1/\partial x_1)$  and  $n_3(\partial n_2/\partial x_2)$ , where the symbols are defined in Definition 5.2.

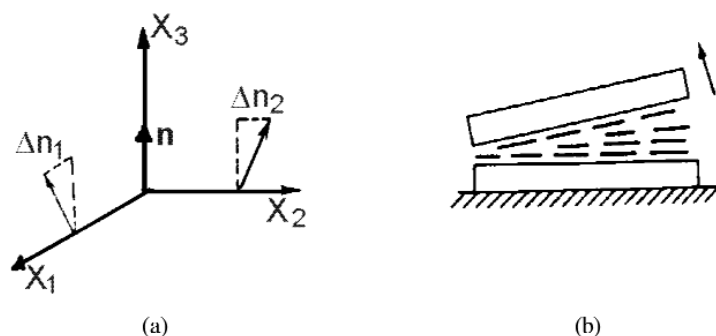

**Fig. 28** Schematic representation of a splay deformation: (a) changes in the components of the director  $\mathbf{n}$ , defining the orientational change; (b) splay deformation of an oriented layer of a nematic liquid crystal.

5.2.2 *bend deformation**Recommended abbreviation: B-deformation*Deformation in the direction of the initial director,  $\mathbf{n}$ , characterized by  $\mathbf{n} \times \text{rot } \mathbf{n} \neq 0$ .*Notes:*

1. See Fig. 29 and Definition 5.3.
2. The degree of bending is given by the component of  $\text{rot } \mathbf{n}$  perpendicular to  $\mathbf{n}$ .
3. A bend deformation is described by the nonzero derivatives  $n_3(\partial n_1/\partial x_3)$  and  $n_3(\partial n_2/\partial x_3)$ , where the symbols are defined in Definition 5.2.

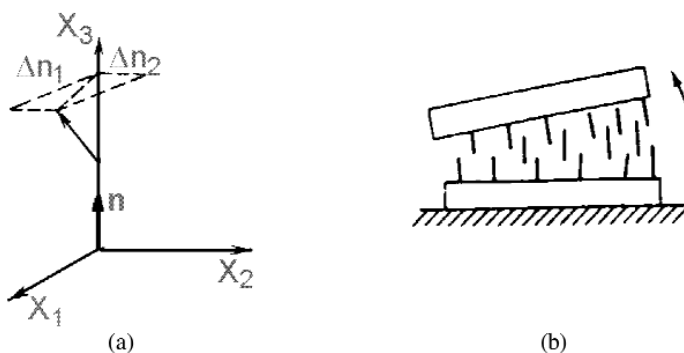

**Fig. 29** Schematic representation of a bend deformation: (a) changes in the components of the director,  $\mathbf{n}$  defining the orientation change; (b) bend deformation of an oriented layer of a nematic liquid crystal.

5.2.3 *twist deformation**Recommended abbreviation: T-deformation*A torsional deformation of a planar-oriented layer in the direction of the initial director,  $\mathbf{n}$ , characterized by  $\mathbf{n} \cdot \text{rot } \mathbf{n} \neq 0$ .*Notes:*

1. See Fig. 30 and Definition 5.3.
2. The degree of twisting is given by the component of  $\text{rot } \mathbf{n}$  parallel to  $\mathbf{n}$ .
3. A twist deformation is defined by the nonzero derivatives  $n_3(\partial n_1/\partial x_2)$  and  $-n_3(\partial n_2/\partial x_1)$ , where the symbols are defined in Definition 5.2.

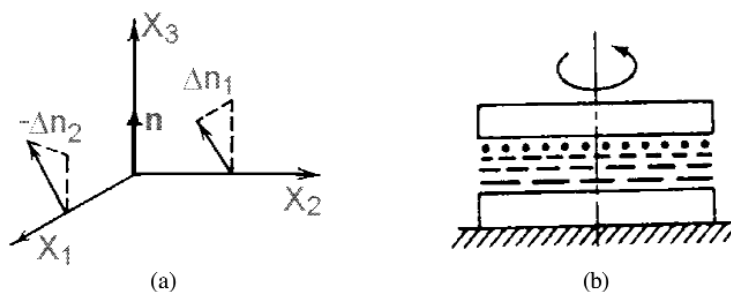

**Fig. 30** Schematic representation of the twist deformation: (a) changes in the components of the director  $\mathbf{n}$ , defining the orientation change. (b) twist deformation of an oriented layer of a nematic liquid crystal.

### 5.3 elastic constants elasticity moduli

**Recommended symbol:**  $K_p$   $i = 1, 2, 3$

**Unit:**  $\text{N m}^{-2}$

Coefficients  $K_1$ ,  $K_2$ , and  $K_3$ , in the expression for the distortion-Gibbs energy density,  $g$ , of a bulk nematic liquid crystal; with

$$g = g_0 + 1/2[K_1 (\text{div } \mathbf{n})^2 + K_2 (\mathbf{n} \times \text{rot } \mathbf{n})^2 + K_3 (\mathbf{n} \times \text{rot } \mathbf{n})^2],$$

where  $g_0$  is the Gibbs-energy density of the undistorted liquid crystal,  $\mathbf{n}$  is the director, and  $K_1$ ,  $K_2$ , and  $K_3$  are the elastic constants for splay, twist, and bend deformations, respectively.

*Notes:*

1. In the equation for  $g$ , the term  $g_0$  is usually equal to zero because the undistorted state of nematics is the state of uniform alignment. However, for chiral nematics, a nonzero value of  $g_0$  allows for the intrinsic twist in the structure. In order to describe  $g$  for smectic phases, an additional term must be added, due to the partially solid-like character of the smectic state and arising from positional molecular deformations.
2. In low-molar-mass nematics composed of rod-like molecules, the bend constant  $K_3$  is the largest while the twist constant  $K_2$  is the smallest. Typical values of  $K_1$  are  $10^{-11}$ – $10^{-12}$   $\text{N m}^{-2}$ .
3. The names of Oseen, Zocher, and Frank are associated with the development of the theory for the elastic behavior of nematics, and so the elastic constants may also be described as the **Oseen–Zocher–Frank constants**, although the term **Frank constants** is frequently used.

### 5.4 Leslie-Ericksen coefficients

**Recommended symbol:**  $\alpha_p$   $i = 1, 2, 3, 4, 5, 6$

**Unit:**  $\text{Pa s}$

The six viscosity coefficients required for a description of the dynamics of an incompressible, nematic liquid crystal.

*Notes:*

1. Assuming Onsager's reciprocal relations for irreversible processes,

$$\alpha_2 + \alpha_3 = \alpha_6 - \alpha_5$$

and the number of independent coefficients reduces to five.

2. For nematics formed by low-molar-mass compounds, the Leslie coefficients are typically in the range  $10^{-2}$  to  $10^{-1}$   $\text{Pa s}$ .

### 5.5 Miesowicz coefficient

**Recommended symbol:**  $\eta_i$   $i = 1, 2, 3$

**Unit:**  $\text{Pa s}$

The ratio of the shear stress,  $\sigma$ , to the shear velocity gradient,  $\gamma$ , for a nematic liquid crystal with a particular director orientation, denoted by  $i$ , under the action of an external field:

$$\eta_i = \sigma / \gamma$$

*Notes:*

1. The three Miesowicz coefficients ( $\eta_1$ ,  $\eta_2$ , and  $\eta_3$ ) describe the shear flow of a nematic phase with three different director orientations, (see Fig. 31) namely:  $\eta_1$  for the director parallel to the shear-flow axis;  $\eta_2$  for the director parallel to the velocity gradient; and  $\eta_3$  for the director perpendicular to the shear flow and to the velocity gradient.

- Usually  $\eta_1 < \eta_2 < \eta_3$ .
- The Miesowicz coefficients are related to the Leslie-Ericksen coefficients (see Definition 5.4) by the relations:

$$\eta_1 = 0.5(\alpha_3 + \alpha_4 + \alpha_6), \quad \eta_2 = 0.5(\alpha_4 + \alpha_5 + \alpha_2), \quad \eta_3 = 0.5(\alpha_4)$$

- The external field used to align the director must be sufficiently large to ensure that it remains aligned during flow.

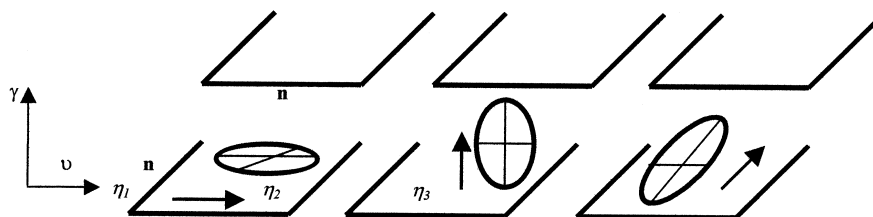

**Fig. 31** Scheme of director alignment in the shear flow of velocity  $v$  of a nematic phase and the corresponding Miesowicz coefficients.

### 5.6 friction coefficients rotational viscosity coefficients *Recommended symbol:* $\gamma_p$ , $i = 1, 2$ *Unit:* Pa s

The coefficients that define the energy dissipation associated with a rotation of the director in an incompressible, nematic liquid crystal.

*Notes:*

- The rotational viscosity coefficients are of the order of  $10^{-2}$ – $10^{-1}$  Pa s for low-molar-mass liquid crystals; for polymeric liquid crystals their values depend strongly on the molar mass of the polymer.
- The friction coefficients can be expressed in terms of the Leslie coefficients as (see Definition 5.4):

$$\gamma_1 = \alpha_3 - \alpha_2 \quad \gamma_2 = \alpha_6 - \alpha_5$$

- $\gamma_1$  is often called the **rotational viscosity** or the **twist viscosity**, i.e., the viscosity associated with the rotation of the director without material flow.

### 5.7 backflow

The motion of a liquid crystal associated with the rate of change of the director in the direction opposite to that of the action of an external field.

### 5.8 anisotropy of physical properties

Dependence of certain physical properties, like the electric permittivity, refractive index, and magnetic susceptibility on direction. It is created by long-range orientational order in a mesophase, provided the corresponding molecular property is anisotropic.

*Note:* The symmetry of the tensor representing the average anisotropic property cannot be lower than the symmetry of the phase.

### 5.8.1 uniaxial mesophase anisotropy

Recommended symbol:  $\Delta\tilde{\chi}$

The value of a property  $\tilde{\chi}$  parallel to the director  $\tilde{\chi}_{//}$  minus that perpendicular to it  $\tilde{\chi}_{\perp}$ :

$$\Delta\tilde{\chi} = \tilde{\chi}_{//} - \tilde{\chi}_{\perp}$$

Notes:

1. The tilde is used to indicate a property of a liquid-crystal mesophase.
2.  $\Delta\tilde{\chi}$  provides a practical measure of the orientational order of a mesophase and necessarily disappears in an isotropic phase.
3. For mesophases composed of cylindrically symmetric molecules there is a precise relationship between the **magnetic anisotropy**,  $\Delta\tilde{\chi}$  and the second-rank orientational parameter  $\langle P_2 \rangle$  (see Definition 5.1).

$$\Delta\tilde{\chi} = (2/3)(\tilde{\chi}_{zz} - \tilde{\chi}_{xx}) \langle P_2 \rangle$$

### 5.8.2 biaxial mesophase anisotropies

Recommended symbols:  $\Delta\tilde{\chi}$  and  $\delta\tilde{\chi}$

With the principal phase axes, corresponding to the three directors ***l***, ***m***, and ***n*** (see Definition 3.3, Note 1) labeled X, Y, and Z such that  $\tilde{\chi}_{zz} > \tilde{\chi}_{xx} > \tilde{\chi}_{yy}$ , the major biaxial mesophase anisotropy,  $\Delta\tilde{\chi}$ , is defined by

$$\Delta\tilde{\chi} = \tilde{\chi}_{zz} - (1/2)(\tilde{\chi}_{xx} + \tilde{\chi}_{yy})$$

and the biaxial mesophase anisotropy is

$$\delta\tilde{\chi} = (\tilde{\chi}_{xx} - \tilde{\chi}_{yy})$$

Notes:

1. The long-range biaxial ordering of the mesophase means that the three principal components of a second-rank tensorial property will not normally be the same, hence, the two measures of the anisotropy  $\Delta\tilde{\chi}$  and  $\delta\tilde{\chi}$ .
2. At a transition to a uniaxial mesophase  $\delta\tilde{\chi}$  vanishes. The **relative biaxiality**,  $\eta$ , is defined as the ratio of  $\delta\tilde{\chi}$  to  $\Delta\tilde{\chi}$ .

## 5.9 ferro-electric effects

A ferro-electric mesophase that appears through the breaking of symmetry in a tilted smectic mesophase by the introduction of molecular chirality and, hence, mesophase chirality.

Notes:

1. When the numbers of layers with opposite tilt directions are not the same, the smectic mesophase has ferro-electric properties.
2. The appearance of a spontaneous polarization,  $|\mathbf{P}_s|$ , in chiral tilted smectic mesophases is caused by a long-range ordering of molecular transverse electric dipoles.
3. The polarization  $|\mathbf{P}_s|$  can be switched between two stable states with an external electric field (***E***); these states are stable in zero electric field.
4. The switching time,  $\tau$ , is given by

$$\tau = \gamma_1 \sin\theta / \mathbf{P}_s \cdot \mathbf{E}$$

where  $\gamma_1$  is the twist viscosity (see Definition 5.6, Note 3) and  $\theta$  is the tilt angle.

5. The spontaneous polarization depends on the transverse component,  $\mu_t$ , of the molecular dipole,

the number density,  $\rho$ , and the polar or first-rank order parameter,  $\langle \cos \varphi \rangle$ , the ensemble average of  $\cos \varphi$ , where  $\varphi$  is the angle between the transverse axis and the minor director, see Definition 3.3, by

$$|P_s| = \rho \mu_t \langle \cos \varphi \rangle$$

6. Typical values of the spontaneous polarization,  $|P_s|$ , in chiral smectic C mesophases are between  $10^{-3}$  and  $10^{-4}$  C m<sup>-2</sup>.
7. When the tilt direction alternates from layer to layer, the smectic mesophase is antiferro-electric; such mesophases do not possess spontaneous polarization. They can be turned into ferro-electric structures through the application of an electric field.

### 5.10 Fréedericksz transition

An elastic deformation of the director, induced by a magnetic or electric field, in a uniformly aligned, thin sample of a nematic confined between two surfaces.

*Notes:*

1. The Fréedericksz transition occurs when the strength of the applied field exceeds a certain threshold value (see Definition 5.11).
2. For a magnetic field this threshold has the form

$$B_{\text{th}} = (\pi / d) (\mu_o K_i / \Delta \tilde{\chi})^{1/2}$$

where  $B_{\text{th}}$  is the threshold magnetic flux density,  $d$  is the thickness of the nematic film and  $\mu_o$  is the permeability of a vacuum and  $\Delta \tilde{\chi}$  is the magnetic anisotropy (see Definition 5.8.1). The particular elastic constant  $K_i$  depends on the geometry of the experiment.

3. For an electric field, this threshold has the form

$$E_{\text{th}} = (\pi / d) (\varepsilon_o K_i / \Delta \tilde{\varepsilon})^{1/2}$$

where  $\varepsilon_o$  is the permittivity of vacuum and  $\Delta \tilde{\varepsilon}$  is the dielectric anisotropy (see Definition 5.8.1).

### 5.11 electroclinic effect

A tilt in an A mesophase is called the electroclinic effect.

*Note:* In high polarization materials induced tilt angles as high as 10° have been observed.

### 5.12 threshold fields

**Recommended symbols:**  $E_{\text{th}}$  (threshold electric field);

$B_{\text{th}}$  (threshold magnetic field)

**Units:** Vm<sup>-1</sup> and T respectively

The critical electric or magnetic field strength necessary to change the equilibrium director alignment imposed by constraining surfaces.

*Note:* See Definition 5.10; Notes 1–3.

### 5.13 electrohydrodynamic instabilities

**Recommended abbreviation:** EHD instabilities

Instabilities caused by the anisotropy of conductivity and corresponding to a periodic deformation of the alignment of the director in a nematic monodomain under the action of a direct current or low-frequency alternating current.

*Notes:*

1. See Definition 4.2 for the definition of a monodomain.
2. The basic electric parameters determining EHD instabilities are the dielectric anisotropy,  $\Delta\tilde{\epsilon}$ , and the anisotropy of the (ionic) conductivity,  $\Delta\tilde{\sigma}$ .  
Distortion of the director, space charges, and the motion of the fluid are coupled through the applied electric field. Above a given threshold, fluctuations of these quantities are amplified and EHD instabilities develop.

#### 5.14 Williams domains Kapustin domains

Regions in a liquid crystal having a specific cellular periodic flow-pattern in the form of long rolls induced by the application of an electric field perpendicular to a nematic layer with an initial planar alignment of the director.

*Notes:*

1. The nematic liquid crystal must have a negative dielectric anisotropy ( $\Delta\tilde{\epsilon} < 0$ ), and a positive conductivity anisotropy ( $\Delta\tilde{\sigma} > 0$ ). The optical texture corresponding to the flow pattern consists of a set of regularly spaced, black and white stripes perpendicular to the initial direction of the director. These stripes are caused by the periodicity of the change in the refractive index for the extraordinary ray due to variations in the director orientation.
2. The domains only exist over a small voltage range (see Definition 5.14).

#### 5.15 dynamic-scattering mode *Recommended abbreviation: DSM*

The state of a liquid crystal that shows a strong scattering of light due to a turbulent flow resulting from an applied voltage greater than a particular critical value.

*Notes:*

1. In DSM the Williams (Kapustin) domains become distorted and mobile, and macroscopic director alignment is completely disturbed.
2. A liquid crystal in DSM has a complicated optical texture.

#### 5.16 flexo-electric effect

The electric polarization resulting from a splay or bend deformation of the director of a nematic liquid crystal.

*Notes:*

1. See Fig. 32.
2. The molecular origins of dipolar flexo-electricity are the particular shape anisotropy (e.g., resembling a pear or banana) of the molecules, each of which must also possess a permanent dipole moment.
3. The net polarization,  $\mathbf{P}$ , is proportional to the distortion:

$$\mathbf{P} = e_1 \mathbf{n}(\text{div } \mathbf{n}) + e_3 (\text{rot } \mathbf{n}) \times \mathbf{n}$$

where  $e_1$  and  $e_3$  are the flexo-electric coefficients. They have the units of an electric potential, namely  $\text{J C}^{-1}$ , of arbitrary sign.

4. The flexo-electric effect is the analog of the piezo-electric effect in solids, where the polarization is induced by a strain that produces a translational deformation of the crystal. The flexo-electric effect in a liquid crystal is caused by a purely orientational deformation.



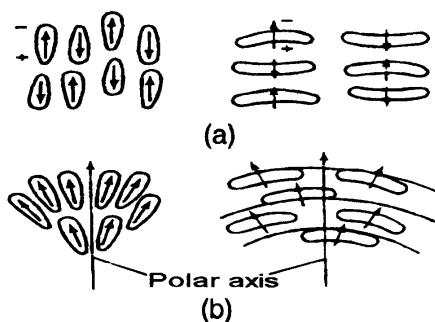

**Fig. 32** Schematic representation of the flexo-electric effect: (a) the structure of an undeformed nematic liquid crystal with pear- and banana-shaped molecules; (b) the same liquid crystal subjected to splay and bend deformations, respectively.

### 5.17 flexo-electric domain

A domain corresponding to a periodic deformation caused by the inverse flexo-electric effect in a nematic liquid crystal.

*Note:* A flexo-electric domain occurs when  $\Delta\tilde{\epsilon} < 4\pi el/K$  where  $e$  is the flexo-electric coefficient and  $K$  is the elastic constant, assuming  $K_1 = K_3 = K$  and  $e_1 = -e_3 = e$  (see Definitions 5.3 and 5.16).

### 5.18 twisted-nematic cell

A twisted nematic liquid crystal sandwiched between two glass plates, with the director aligned parallel to the plates, with one of the plates turned in its own plane about an axis normal to it.

### 5.19 “time-on” of the electro-optical effect

#### turn-on time

**Recommended symbol:**  $\tau_{\text{on}}$

**Unit:** s

The time required for the light intensity viewed through crossed polarizers to increase to 90% of the final value from the off-state to the on-state of an electro-optical twisted-nematic cell.

*Note:* In the off-state the electro-optical cell contains a thin film of a nematic liquid crystal with mutually perpendicular directors at the upper and lower glass plates; hence, to reach the on-state the director performs a  $90^\circ$  twist over the thickness of the liquid-crystal film.

### 5.20 “time-off” of the electro-optical effect

#### turn-off time

**Recommended symbol:**  $\tau_{\text{off}}$

**Unit:** s

The time required for the light intensity viewed through crossed polarizers to decrease by 90% from the on-state to the off-state of an electro-optical twisted-nematic cell.

*Note:* See the note to Definition 5.19.

### 5.21 rise time

**Unit:** s

The time required by an electro-optical nematic cell for a light-intensity change from 10 to 90% of the maximum intensity on going from the off-state to the on-state.

*Note:* See the note to Definition 5.19.

**5.22 fall time  
decay time  
Unit: s**

The time required by an electro-optical twisted-nematic cell for a light-intensity change from 90% to 10% of the maximum intensity on going from the on-state to the off-state.

*Note:* See the note to Definition 5.19.

**5.23 guest-host effect**

Field-induced change in the orientation of either dichroic dye molecules (the guest) dissolved in a mesophase (the host) or dichroic dye moieties (the guest) of polymers (the host) resulting in changes in the absorption spectrum of a mesomorphic mixture.

**6. LIQUID-CRYSTAL POLYMERS**

**6.1 liquid-crystal polymer  
polymer liquid crystal  
liquid-crystalline polymer  
Recommended abbreviations: LCP and PLC**

A polymer material that, under suitable conditions of temperature, pressure and concentration, exists as a LC mesophase.

**6.2 main-chain polymer liquid crystal  
main-chain liquid-crystalline polymer  
Recommended abbreviation: MCPLC or MCLCP**

A polymer containing mesogenic units in their main chains but not in side-chains.

*Notes:*

1. A MCPLC is formed by linking together suitable relatively rigid units directly or through appropriate functional groups (see Fig. 33).
2. The linkage between the rigid units (I) may be (a) direct or (b–g) via flexible spacers (II) (see Definition 6.4).
3. A MCPLC with cross-shaped mesogenic groups (b or g) is known as a **cruciform (or star) polymer liquid crystal**.
4. The rigid units may, but often do not, possess intrinsic mesogenic character.

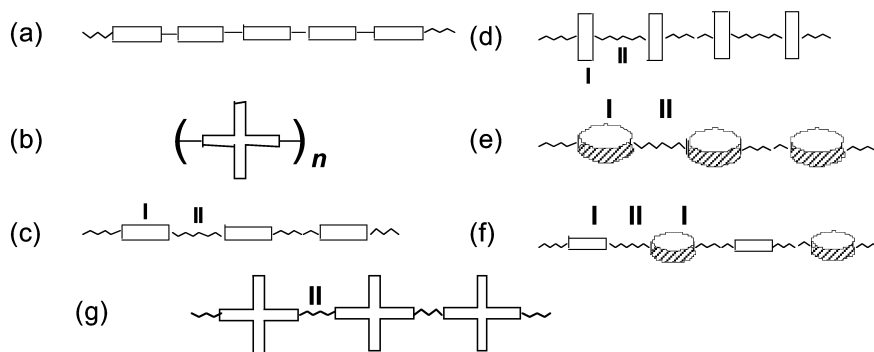

**Fig. 33** Examples of main-chain polymer liquid crystals: I - mesogenic group; II - spacer.

**6.3 side-group or side-chain polymer liquid crystal  
side-group or side-chain liquid-crystalline polymer  
polymer with mesogenic side-groups or side-chains  
comb-shaped (comb-like) polymer liquid crystal  
Recommended abbreviation: SGPLC, SCPLC, SGLCP, SCLCP**

A polymer, the molecules of which have mesogenic units only in the side-groups side-chains.

Notes:

1. The mesogenic groups (I) in a SGPLC can be connected to the backbone (III) either (a) directly or (b, c) via flexible spacers (II) (see Fig. 34).
2. The structures as in Fig. 34 can also be used with the proviso that the side-group units are replaced by chains containing mesogens.
3. Examples of polymer backbones are polyacrylates, polymethacrylates, and polysiloxanes; the spacers are usually polymethylene, polyoxyethylene, or polysiloxane fragments.
4. The pendant groups in these polymers have structures compatible with liquid-crystal formation, that is, they are mesogenic but not intrinsically mesomorphic. See the examples given in Definitions 2.10; 2.11.2.1.
5. If the mesogenic side-groups are rod-like (calamitic) in nature, the resulting polymer may, depending upon its detailed structure, exhibit any of the common types of calamitic mesophases: nematic, chiral nematic, or smectic. Side-on fixed SGPLC, however, are predominantly nematic or chiral nematic in character. Similarly, disc-shaped side-groups tend to promote discotic nematic or columnar mesophases while amphiphilic side-chains tend to promote amphiphilic or lyotropic mesophases.
6. A plethora of types of copolymers can be produced. For example, nonmesogenic side-groups may be used in conjunction with mesogenic side-groups and the polymer backbone may be substituted, to various degrees, with side-groups or chains.

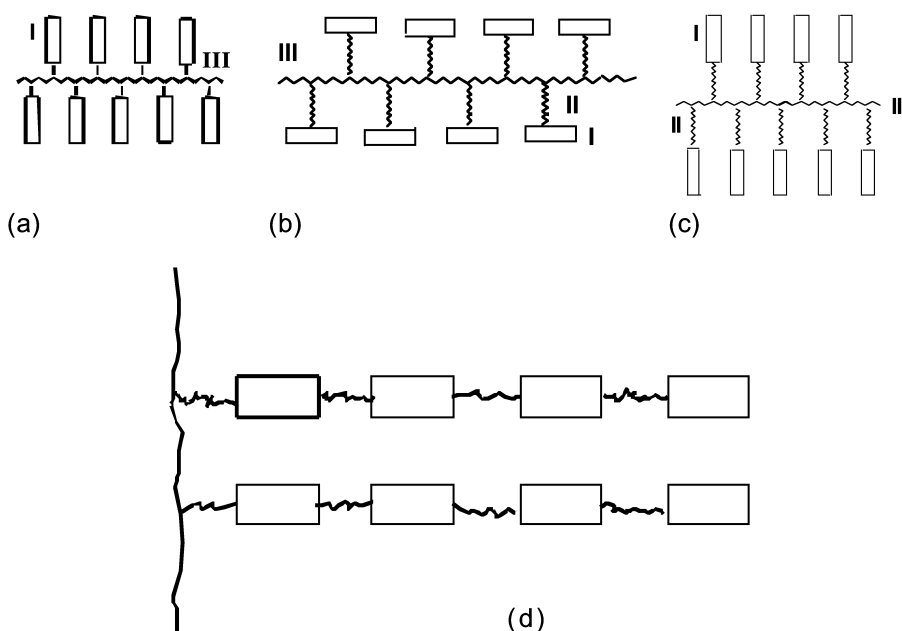

**Fig. 34** Examples of side-group polymer liquid crystals: I - mesogenic group; II - spacer; III - backbone. The terminology “**side-group**” is used for (a), “**side-on fixed**” is used for (b), “**end-on fixed**” for (c) and “**side-chain**” for (d).

#### 6.4 spacer

A flexible segment used to link successive mesogenic units in the molecules of MCPLCs or to attach mesogenic units as side-groups onto the polymer backbone of SGPLCs.

*Notes:*

1. Examples of spacers are: polymethylene, polyoxyethylene, or polysiloxane chains.
2. The term is also used for the group linking two or more mesogenic units in liquid-crystal oligomers (see Definition 2.11.2.9).

#### 6.5 disruptor

A chemical group used to disrupt the linearity of the backbone of molecules of MCLCPs.

*Note:* Examples are (a, b) rigid-kink or (c) crankshaft units.

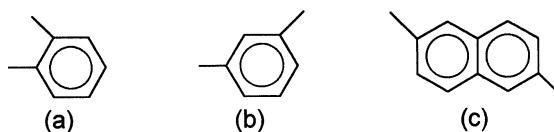

#### 6.6 combined liquid-crystalline polymer

A liquid-crystalline polymer consisting of macromolecules in which mesogenic groups are incorporated both in the main-chain and in the side-groups.

*Note:* See Fig. 35. The mesogenic side-groups can be attached either as lateral substituents to the backbone mesogenic moieties that are connected to each other either (a) directly or (b) by spacers or (c) they can be attached to the spacer incorporated into the main-chain.

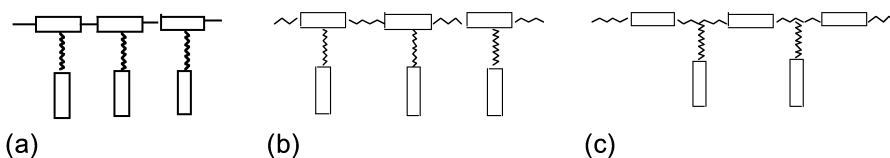

**Fig. 35** Examples of combined liquid-crystalline polymers.

#### 6.7 rigid chain

The rod-like chain of a MCPLC with direct links between the mesogenic groups for which the persistence length is at least comparable with the contour length and much greater than the diameter.

*Notes:*

1. The persistence length is a characteristic of the stiffness of a chain in the limit of infinite chain length [see *Compendium of Macromolecular Nomenclature*, W. V. Metanovski (Ed.), p. 47, Blackwell Scientific Publications, Oxford, 1988].
2. A polymer composed of molecules that have rigid rod-like groups or chains usually does not show thermotropic mesomorphic behavior because decomposition occurs below its melting point.
3. A polymer composed of molecules that have rigid rod-like groups or chains may form LC mesophases in solution under suitable conditions. These are sometimes described as lyotropic but, as the solvent does not induce the formation of aggregates or micelles, this term is not appropriate.

#### 6.8 semi-rigid chain

A chain for which the contour length is greater than the persistence length but for which their ratio is still below the Gaussian limit.

*Note:* Some polymers composed of semi-rigid chains form amphiphilic mesogens (see Definition 2.11.1).

*Examples:* Polyisocyanates and (2-hydroxyethyl)cellulose.

### 6.9 board-shaped polymer

A polymer chain composed of a rigid backbone to which many lateral side-groups are attached, giving the repeat unit a board-like shape.

*Notes:*

- The rigid backbone often has a polyester, polyamide, or poly(ester-amide) type of structure. Examples are:

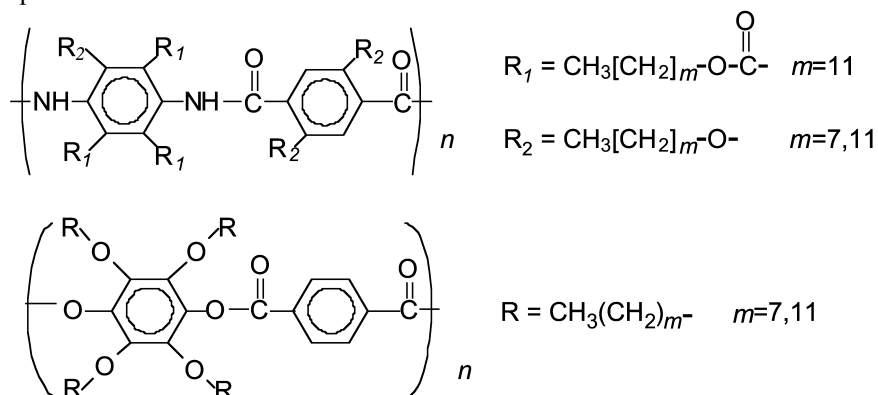

- A polymer LC consisting of macromolecules of board-like shape can be called a board-shaped polymer LC. Such polymers can form smectic mesophases (see Definition 3.4).

### 6.10 liquid-crystal dendrimer dendrimeric liquid crystal dendritic liquid crystal

A highly branched oligomer or polymer of dendritic structure containing mesogenic groups that can display mesophase behavior.

*Notes:*

- See Fig. 36. The mesogenic groups can be located along the chains of the molecule (a) or can occur as terminal groups (b).
- The mesogenic groups can be, e.g., rod- or disc-like, and can be attached laterally or longitudinally to the flexible spacers.

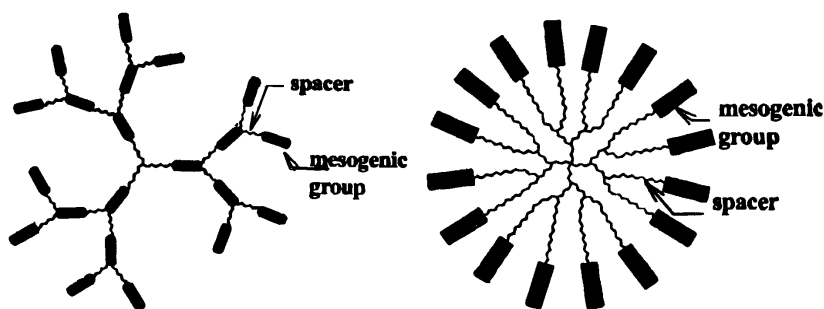

**Fig. 36** Liquid-crystal dendrimers: (a) with mesogenic groups in the whole volume of a macromolecule; (b) with terminal mesogenic groups.

### 6.11 hyperbranched-polymer liquid crystal

A polymer composed of highly branched macromolecules containing mesogenic groups of which any linear subchain generally may lead in either direction, to at least two other subchains.

### 6.12 banded texture band texture

Alternating dark and bright bands observed, following shear, in a wide range of main-chain nematic and chiral nematic liquid-crystalline polymers.

*Notes:*

1. The bands always lie perpendicular to the prior shear direction.
2. In general, bands form after the cessation of shear, but, under some circumstances, they may appear during the flow process
3. The bands are associated with a periodic variation in the director orientation about the flow axis.

## 7. REFERENCES

1. D. Demus, G. W. Gray, H. W. Spiess, V. Vill (Eds.). *Handbook of Liquid Crystals*, Vols. Q, 2a, 2b, and 3, Wiley-VCH, New York (1998).
2. W. Brostow (Ed.). *Polymer Liquid Crystals Mechanical and Thermophysical Properties*, Chapman & Hall, London (1996).
3. V. Vill. LIQCRYST 2.1, Database of Liquid Crystalline Compounds for Personal Computers, LCI Publisher GmbH, Hamburg (1996).
4. L. M. Blinov and V. G. Chigrinov. *Electrooptic Effects in Liquid Crystal Materials*, Springer-Verlag, New York (1994).
5. V. P. Shibaev and Lui Lam (Eds.). *Liquid Crystalline and Mesomorphic Polymers*, Springer-Verlag, New York (1994).
6. H. Stegmeyer (Ed.). *Topics in Physical Chemistry*, Vol. 3, *Liquid Crystals*, Springer, New York (1994).
7. G. R. Luckhurst and C. A. Veracini (Eds.). *The Molecular Dynamics of Liquid Crystals*, Kluwer, Dordrecht (1994).
8. P. G. de Gennes and J. Prost. *The Physics of Liquid Crystals*, 2<sup>nd</sup> ed., Clarendon Press, Oxford (1993).
9. N. A. Platé (Ed.). *Liquid-Crystal Polymers*, Plenum Press, New York (1993).
10. S. Chandrasekhar. *Liquid Crystals*, 2<sup>nd</sup> ed., University Press, Cambridge (1992).
11. A. M. Donald and A. H. Windle. *Liquid Crystalline Polymers*, Cambridge University Press, Cambridge (1992).
12. A. A. Collyer (Ed.). *Liquid Crystal Polymers: From Structures to Applications*, Elsevier Applied Science, London (1992).
13. V. Vill. "Liquid Crystals" in *Landolt-Börnstein. Numerical Data and Functional Relationships in Science and Technology. New Series. Group IV: Macroscopic and Technical Properties of Matter*, Vol. 7, Subvolumes a–f, Springer-Verlag, Berlin (1992– not yet completely published).
14. A. Ciferri (Ed.). *Liquid Crystallinity in Polymers. Principles and Fundamental Properties*, VCH, New York (1991).
15. C. Noel and P. Navard. *Prog. Polym. Sci.* **16**, 55–110 (1991).
16. J. W. Goodby (Ed.) "Ferroelectric Liquid Crystals", Gordon and Breach, Philadelphia, 1991.
17. B. Bahadur (Ed.). *Liquid Crystals. Applications and Uses*, Vols. 1–3, World Scientific, Singapore (1990/1992).
18. W. Brostow. *Polymer* **31**, 979 (1990).
19. D. Demus. *Liq. Cryst.* **5**, 75 (1989).

20. C. B. McArdle (Ed.). *Side-Chain Liquid Crystal Polymers*, Blackie, Glasgow (1989).
21. N. A. Platé and V. P. Shibaev. *Comb-Shaped Polymers and Liquid Crystals*, Plenum, New York (1988).
22. B. S. Hsiao, M. T. Shaw, E. T. Samulski. *Macromolecules* **21**, 543 (1988).
23. G. Vertogen and W. H. De Jeu. *Thermotropic Liquid Crystals, Fundamentals*, Springer Series in Classical Physics, Vol. 45, Springer-Verlag, Berlin (1988).
24. S. Chandrasekhar and N. V. Madhusudana. *Proc. Indian Acad. Sci. (Chem. Sci.)* **94**(1), 139–179 (1985).
25. A. Blumstein (Ed.). *Polymeric Liquid Crystals*, Plenum, New York (1985).
26. L. Chapoy (Ed.). *Recent Advances in Liquid-Crystalline Polymers*, Elsevier Applied Science, London (1985).
27. E. T. Samulski. *Faraday Discuss. Chem. Soc.* **79**, 7–20 (1985).
28. G. W. Gray and J. W. Goodby. *Sanidic Liquid Crystals*, Lenard Hill, Glasgow (1984).
29. B. Wunderlich and J. Grebowicz. *Adv. Polym. Sci.* **60/61**, 2–59 (1984).
30. D. Demus, H. Demus, H. Zschke. *Flüssige Kristalle in Tabellen II*, VEB f. Grunstoffindustrie, Leipzig (1984).
31. W. H. De Jeu. *Phil. Trans. Roy. Soc., London, Ser. A* **304**, 217–29 (1983).
32. A. Ciferri, W. Krigbaum, R. Meyer (Eds.). *Polymer Liquid Crystals*, Academic, New York (1982).
33. H. Kelker and R. Hatz. *Handbook of Liquid Crystals*, Verlag Chemie, Weinheim (1980).
34. G. R. Luckhurst and G. W. Gray (Eds.). *The Molecular Physics of Liquid Crystals*, Academic Press, London (1979).
35. D. Demus and L. Richter. *Textures of Liquid Crystals*, Verlag Chemie, Weinheim (1978).
36. G. W. Gray and P. A. Winsor (Eds.). *Liquid Crystals and Plastic Crystals*, Vols. 1 and 2, Ellis Horwood, Chichester (1974).
37. D. Demus, H. Demus, H. Zschke. *Flüssige Krystalle in Tabellen*, VEB Verlag für Grundstoffindustrien, Leipzig (1974).
38. P. H. Hermans. *Contribution to the Physics of Cellulosic Fibres*, Elsevier, Amsterdam (1946).
39. M. Miesowicz. *Nature* **158**, 27 (1946).

## 8. ALPHABETICAL INDEX OF TERMS

- |   |  |
|---|--|
| adhering thread, 4.9.3.1                                  | biaxial smectic A mesophase, 3.3.2         |
| amphiphilic mesogen, 2.11.1                               | biforked mesogen, 2.11.2.5                 |
| amphitropic compound, 2.4.4                               | bipolar droplet texture, 4.9.1.1           |
| anisotropy of physical properties, 5.8                    | bis-swallow-tailed mesogen, 2.11.2.7       |
| antiferro-electric chiral smectic C meso phase, 3.1.5.1.2 | blue phase, 3.1.4                          |
| antimesophase, 3.1.6.3                                    | board-shaped polymer, 6.9                  |
| asymmetric liquid-crystal dimer, 2.11.2.9                 | boojums, 4.9.1.1                           |
| backflow, 5.7   | boundaries of Grandjean, 4.10.4            |
| banana mesogen, 2.11.2.10                                 | bowlic mesogen, 2.11.2.3                   |
| band texture, 6.12  | calamitic mesogen, 2.11.2.1                |
| banded texture, 6.12                                      | centered rectangular mesophase, 3.1.6.3    |
| barotropic mesophase, 2.4.2                               | chiral columnar oblique mesophase, 3.2.2.3 |
| bâtonnet, 4.10.1  | chiral nematic, 3.1.3                      |
| bend deformation, 5.2.2                                   | chiral nematic mesophase, 3.1.3            |
| biaxial mesophase, 3.3                                    | chiral nematogen, 2.11                     |
| biaxial mesophase anisotropies, 5.8.2                     | chiral smectic C mesophase, 3.1.5.1.3      |
| biaxial nematic, 3.3.1                                    | chiral smectic F mesophase, 3.1.5.2.2      |
| biaxial nematic mesophase, 3.3.1                          | chiral smectic I mesophase, 3.1.5.2.3      |
|   | cholesteric, 3.1.3                         |

- cholesteric mesophase, 3.1.3
- clearing point, 2.6
- clearing temperature, 2.6
- columnar discotic, 3.2.2
- columnar discotic mesophase, 3.2.2
- columnar hexagonal mesophase, 3.2.2.1
- columnar mesophase, 3.2.2
- columnar oblique mesophase, 3.2.2.2
- columnar rectangular mesophase, 3.2.2.2
- combined liquid-crystalline polymer, 6.6
- comb-shaped (comb-like) polymer liquid crystal, 6.3
- comb-shaped mesogen, 2.11.2.3
- conical mesogen, 2.11.2.3
- cruciform polymer liquid crystal, 6.2
- cybotactic groups, 3.1.2
- crystal B, E, G, H, J, and K mesophases, 3.1.5.3
- cubic mesophase, 3.1.9
- decay time, 5.21
- defect, 4.7
- dendrimeric liquid crystal, 6.10
- dendritic liquid crystal, 6.10
- divergence temperature, 2.9
- director, 3.1.1.1
- disclination, 4.7.2
- disclination strength, 4.9.2.2
- discoïd mesogen, 2.11.2.2
- discotic mesogen, 2.11.2.2
- discotic mesophases, 3.2
- discotic, 3.2.1
- discotic nematic mesophase, 3.2.1
- discotics, 3.2
- dislocation, 4.7.1
- disruptor, 6.5
- distortion in liquid crystals, 5.2
- divergence temperature, 2.9
- domain, 4.1
- dynamic-scattering mode, 5.15
- elastic constants, 5.3
- elasticity moduli, 5.3
- electroclinic effect, 5.11
- electrohydrodynamic instabilities, 5.13
- enantiotropic mesophase, 2.4.1
- end-on fixed side-group polymer liquid crystal, 6.3
- even-membered liquid-crystal dimer, 2.11.2.9
- fall time, 5.22
- ferro-electric effects, 5.9
- flexo-electric domain, 5.17
- flexo-electric effect, 5.16
- focal-conic domain, 4.10.2
- focal-conic, fan-shaped texture, 4.10.4
- forked hemiphasmidic mesogen, 2.11.2.5
- Frank constants, 5.3
- Fréedericksz transition, 5.10
- friction coefficients, 5.6
- fused twin mesogen, 2.11.2.9
- general definitions, 2
- glassy mesophase, 3.5
- guest-host effect, 5.23
- hemiphasmidic mesogen, 2.11.2.5
- hexagonal mesophase, 3.2.2.1
- hexatic smectic mesophase, 3.1.5.2
- homeotropic alignment, 4.3
- homogeneous alignment, 4.4
- hyperbranched-polymer liquid crystal, 6.11
- induced mesophase, 3.1.8
- intercalated smectic mesophase, 3.1.7
- inverse hexagonal mesophase, 3.2.2.1
- inverse lamellar mesophase, 3.1.5.1.1
- isotropization temperature, 2.6
- Kapustin domains, 5.14
- lamellar mesophase, 3.1.5.1.1
- laterally branched mesogen, 2.11.2.8
- Leslie–Ericksen coefficients, 5.4
- ligated twin mesogen, 2.11.2.9
- liquid crystal, 2.3
- liquid-crystal dendrimer, 6.10
- liquid-crystal dimer, 2.11.2.9
- liquid-crystal oligomer, 2.11.2.9
- liquid-crystal polymer, 6.1
- liquid-crystal polymers, 6
- liquid-crystal state, 2.2
- liquid-crystalline phase, 2.2.1
- liquid-crystalline polymer, 6.1
- liquid-crystalline state, 2.2
- lyotropic mesophase, 2.4.3
- magnetic mesophase anisotropy, 5.8.1
- main-chain liquid-crystalline polymer, 6.2
- main-chain polymer liquid crystal, 6.2
- marbled texture, 4.9.4
- major biaxial mesophase anisotropy, 5.8.2
- melted-grain boundary mesophase, 3.6.3
- mesogen, 2.11
- mesogenic compound, 2.11
- mesogenic dimer, 2.11.2.9
- mesogenic group, 2.10
- mesogenic moiety, 2.10
- mesogenic oligomer, 2.11.2.9
- mesogenic unit, 2.10



- mesomorphic compound, 2.1, 2.11
- mesomorphic glass, 2.1
- mesomorphic state, 2.1
- mesomorphous state, 2.1
- mesophase, 2.4
- mesophases of calamitic mesogens, 3.1
- mesophases of disc-like mesogens, 3.2
- metallomesogen, 2.11.3
- Miesowicz coefficient, 5.5
- m,n*-polycatenary mesogen, 2.11.2.5
- modulated smectic mesophase, 3.1.6.3
- monodomain, 4.2
- monotropic mesophase, 2.4.5
- nematic, 3.1.1
- nematic droplet, 4.9.1
- nematic textures, 4.9
- nematogen, 2.11
- nonamphiphilic mesogen, 2.11.2
- nucleus, 4.9.2.1
- oblique mesophase, 3.1.6.3
- odd-membered liquid-crystal dimer, 2.11.2.9
- optical texture, 4.8
- order parameter, 5.1
- ordered sanidic phase, 3.4.2
- Oseen–Zocher–Frank constants, 5.3
- parabolic focal conic domain, 4.10.2
- phasmidic mesogen, 2.11.2.5
- physical characteristics of liquid crystals, 5
- planar alignment, 4.4
- polycatenary mesogen, 2.11.2.5
- polygonal texture, 4.10.3
- polymer liquid crystal, 6
- polymer with mesogenic side-groups or side-chains, 6.3
- polymorphic modifications of strongly polar compounds, 3.1.6
- pretilted homeotropic alignment, 4.3
- pretransitional temperature, 2
- pyramidic mesogen, 2.11.2.3
- radial droplet texture, 4.9.1.2
- rectangular sanidic mesophase, 3.4.1
- re-entrant mesophase, 3.1.6.1
- relative biaxiality (of a biaxial mesophase), 5.8.2
- ribbon mesophase, 3.1.6.3
- rigid chain, 6.7
- rise time, 5.21
- rotational viscosity, 5.6
- rotational viscosity coefficients, 5.6
- sanidic mesogen, 2.11.2.4
- sanidic mesophase, 3.4
- schlieren texture, 4.9.2
- semi-rigid chain, 6.8
- side-chain liquid-crystalline polymer, 6.3
- side-chain polymer liquid crystal, 6.3
- side-group liquid-crystalline polymer, 6.3
- side-group polymer liquid crystal, 6.3
- side-on fixed side-group polymer liquid crystal, 6.3
- side-to-tail twin mesogen, 2.11.2.9
- smectic  $A_1$ ,  $A_d$ ,  $A_2$ ,  $C_1$ ,  $C_d$ ,  $C_2$  mesophases, 3.1.6.2
- smectic A mesophase, 3.1.5.1.1
- smectic B mesophase, 3.1.5.2.1
- smectic C mesophase, 3.1.5.1.2
- smectic F mesophase, 3.1.5.2.2
- smectic I mesophase, 3.1.5.2.3
- smectic mesophase, 3.1.5
- smectic mesophases with unstructured layers: SmA and SmC, 3.1.5.1
- smectic textures, 4.10
- smectogen, 2.11
- spacer, 6.4
- splay deformation, 5.2.1
- star polymer liquid crystal, 6.2
- surface disclination line, 4.9.3.1
- surface pretilt, 4.3
- swallow-tailed mesogen, 2.11.2.6
- tail-to-tail twin mesogen, 2.11.2.9
- textures and defects, 4
- thermotropic mesophase, 2.4.1
- threaded texture, 4.9.3
- threshold field, 5.12
- threshold electric field, 5.12
- threshold magnetic field, 5.12
- “time-off” of the electro-optical effect, 5.20
- “time-on” of the electro-optical effect, 5.19
- transitional entropy, 2.8
- transition temperature, 2.5
- turn-off time, 5.19
- turn-on time, 5.18
- twin mesogen, 2.11.2.9
- twist alignment, 4.6
- twist deformation, 5.2.3
- twisted-nematic cell, 5.18
- twist grain-boundary mesophase, 3.6
- twist grain-boundary  $A^*$  mesophase, 3.6.1
- twist grain-boundary  $C^*$  mesophase, 3.6.2
- twist viscosity, 5.6
- types of mesophase, 3
- uniaxial mesophase anisotropy, 5.8.1

## 9. GLOSSARY OF RECOMMENDED ABBREVIATIONS AND SYMBOLS

### 9.1 Abbreviations

B-deformation	bend deformation
BP	blue phase
Col	columnar discotic mesophase, columnar mesophase
Col <sub>h</sub>	columnar hexagonal mesophase
Col <sub>ob</sub>	columnar oblique mesophase
Col <sub>r</sub>	columnar rectangular mesophase
Cub	cubic mesophase
Cr	crystalline phase
DSM	dynamic-scattering mode
EHD instabilities	electrohydrodynamic instabilities
I	isotropic phase
LC	liquid-crystal, liquid-crystalline state, liquid-crystal phase, liquid-crystalline phase
LCPL	liquid-crystalline phase, liquid-crystalline polymer
MCLCP	main-chain liquid-crystalline polymer
MCPLC	main-chain polymer liquid crystal
MGBC*	melted-grain-boundary mesophase
PLC	polymer liquid crystal
re (subscript)	re-entrant mesophase
SCLCP	side-chain liquid-crystal polymer
SCPLC	side-chain polymer liquid crystal
S-deformation	splay deformation
SGLCP	side-group liquid-crystal polymer
SGPLC	side-group polymer liquid crystal
Sm	smectic mesophase
SmA, SmA <sub>1</sub> , SmA <sub>2</sub> , SmA <sub>d</sub>	smectic A mesophases
SmA <sub>b</sub>	biaxial smectic A mesophase
SmB, SmB <sub>hex</sub>	smectic B mesophase
SmC*	chiral smectic C mesophase
SmC, SmC <sub>1</sub> , SmC <sub>2</sub> , SmC <sub>d</sub>	smectic C mesophases
SmF	smectic F mesophase
SmF*	chiral smectic F mesophase
SmI*	smectic I mesophase
SmI*	chiral smectic I mesophase
T-deformation	twist deformation
TGB	twist grain-boundary mesophases
TGBA*	twist grain-boundary A* mesophase
TGBC*	twist grain-boundary C* mesophase

## 9.2

## Symbols

$\alpha_i$	Leslie coefficient, Leslie–Ericksen coefficient
$\gamma_i$	friction coefficient, rotational viscosity coefficient
$\eta$	relative biaxiality of a biaxial mesophase
$\eta_i$	Miesowicz coefficient
$\tau_{\text{off}}$	“time-off” of the electro-optical effect
$\tau_{\text{on}}$	“time-on” of the electro-optical effect
$\Delta S_{XY}$	transitional entropy
$\Sigma$	sanidic mesophase
$\Sigma_o$	ordered sanidic phase
$\Sigma_r$	rectangular sanidic mesophase
$\sim$	(tilde) modulated smectic mesophases
$a$	distortion in liquid crystals
$b$	(subscript) biaxial mesophase
$B_{\text{th}}$	threshold magnetic field
$c$	(subscript) intercalated smectic mesophase
$e_1, e_3$	flexo-electric coefficient
$E_{\text{th}}$	threshold electric field
$g$	(subscript) glassy mesophase
$K_i$	elastic constants, elasticity moduli
$l$	director in a biaxial mesophase
$m$	director in a biaxial mesophase
$N$	nematic, discotic nematic mesophase
$n$	director
$n_i$	director component
$N^*$	chiral nematic, chiral nematic mesophase, cholesteric mesophase
$N_b$	biaxial nematic mesophase
$N_u$	uniaxial nematic mesophase, nematic
$\langle P_2 \rangle$	order parameter
$P$	net polarization
$P_s$	spontaneous polarization
$s$	disclination strength
$T^*$	divergence temperature, pretransitional temperature
$T_{\text{cl}}$	clearing point, clearing temperature
$T_i$	isotropization temperature
$T_{XY}$	transition temperature, with X and Y being abbreviations for mesophases or a phase and a mesophase
*	tilted smectic mesophase